

StudioComm for Surround

Model 68A Central Controller and Model 69A Control Console

User Guide

Issue 2, January 2005

This User Guide is applicable for systems consisting of:
Model 68A: serial number M68A-00501 and later;
Model 69A: M69A-00742 and later

© 2005 by Studio Technologies, Inc., all rights reserved

www.studio-tech.com

This page intentionally left blank.

Table of Contents

Foreword	5
Introduction.....	7
Installation	10
Configuration	14
Operation.....	30
Technical Notes.....	34
Specifications	38
Appendix A.....	39
MIDI Messages	40
Block Diagrams	
Model 68A Central Controller	
Model 69A Control Console	

This page intentionally left blank.

Foreword

Simply stated: I had a blast working on the StudioComm for Surround components! It was very rewarding to develop a set of products for a market that's actually receptive to new ideas and supportive of innovation.

A big thanks to Jeff Levison of DTS. He patiently answered my questions over a period of many months, helping to guide me in the right direction. Additional thanks to a couple of smart audio dudes. Thierry Jeandroz of LTRT in Paris encouraged me to add several features to improve our audio-post support. Rob James, formerly of the BBC and now a consultant and writer, suggested how the operator interface could be improved. The software now reflects the sage advice of these gentlemen. Mike "Mr. Surround" Sokol suggested the exclusive solo mode as well as presenting a convincing case for adding down-mix capability.

Mitch Budniak designed much of the hardware and kept us out of "digital trouble." Carrie Loving provided engineering support and designed the product graphics. Larry Leviton and Paul Berland wrote the software that makes the hardware "come to life." Fred Roeck performed the mechanical design. Al "PCB PRO" Lux designed the...you guessed it! Joe Urbanczyk coordinated the safety testing and created the automated test routes for our Audio Precision System Ones.

Our plans are to continue with other StudioComm for Surround components. To help keep us going in the right direction, your praise, comments, or complaints are encouraged. Please contact me via E-mail at gkapes@studio-tech.com.

Sincerely,

Gordon K. Kapes
President

This page intentionally left blank.

Introduction

What This User Guide Covers

This User Guide is designed to assist you when installing and using the Model 68A Central Controller and the Model 69A Control Console.

StudioComm for Surround

As the production of multi-channel “surround sound” audio material becomes more prevalent, the need to monitor these sources becomes imperative for more and more facilities. Studio Technologies has addressed the needs of smaller facilities with the StudioComm Model 68A Central Controller and Model 69A Control Console. Together they provide a means to select input sources, control the level of monitor loudspeakers, check format compatibility, provide mute and solo functions, as well as many other features.

A StudioComm for Surround system starts with a Model 68A Central Controller. The single-rack space Model 68A supports two 6-channel surround inputs, two stereo inputs, a 6-channel surround monitor output, and a stereo monitor output. Using a single 9-conductor cable, it connects to a Model 69A Control Console, a compact but comfortable “command center” that is designed to reside at the operator’s location.

The Models 68A and 69A were developed in conjunction with experts in the post-production and music audio fields. The overall goal turned out to be very straightforward: provide the necessary technical performance and features, while keeping it simple to operate! Be certain that operators won’t have to go through a long “learning curve” before they become efficient. The

end result achieves these goals, providing the required resources in a simple-to-operate format.

Model 68A Central Controller

The Model 68A Central Controller is a single rack-space unit containing analog audio and digital control circuitry. Audio input and output connections are made using three 25-pin D-subminiature (“D-sub”) connectors. The connectors follow the industry-standard multi-channel wiring scheme. A 9-pin D-sub connector is used to connect the Model 68A to a Model 69A Control Console. A second 9-pin D-sub connector provides access to the remote control inputs.

The Model 68A provides two 6-channel surround and two stereo inputs. Each input circuit uses a 15-turn trim potentiometer to allow operation with nominal signal levels of -12 dBV to $+6$ dBu. The 6-channel surround and 2-channel stereo monitor outputs use electronically balanced circuitry. Electromechanical relays provide power-up and power-down loudspeaker protection.

An 8-bit micro-controller provides the logic “horsepower” for the Model 68A. AC mains power is connected directly to the Model 68A, which is factory selected for 100, 120, 220/240 V operation. The internal power supply utilizes a toroidal mains transformer for quiet audio operation.

Model 69A Control Console

The Model 69A Control Console is a compact, self-contained unit designed to be located at the operator’s position. It allows fingertip control of all monitoring parameters. Numerous LEDs provide complete status information.

The Model 69A provides four buttons and associated LEDs for selection of the input source to be monitored. While in most cases only one input source will be monitored at a time, multiple inputs can be selected for simultaneous monitoring. This allows two, three, or all four of the inputs to be combined (“summed”). While there is no independent control of the input levels, this feature can be useful for creating rough mixes from the source signals. It is also a fast, effective means of making a “seat-of-the-pants” check on the phase relationship between synchronized signals.

The monitor output level is controlled either through the use of a large, easy-to-use rotary control, or by enabling the preset reference level. For operator convenience, the dim function allows the monitor output level to be reduced by a fixed dB

amount. The mute all function disables all monitor outputs by activating the mute relays on the Model 68A Central Controller. A pushbutton switch allows selection of either the 6-channel surround or the 2-channel stereo monitor output.

Control of the individual monitor output channels is provided by the mute/solo section. One pushbutton switch sets the operating mode for either mute or solo. The flexibility of having both mute and solo available allows an operator to quickly select the most comfortable and productive operating mode. In the mute mode, individual channels can be muted or unmuted as required. In the solo mode, one channel can be monitored while the others are automatically muted. If desired, multiple channels can be simultaneously selected for “soloing.”

Figure 1. Model 68A Central Controller Front Panel

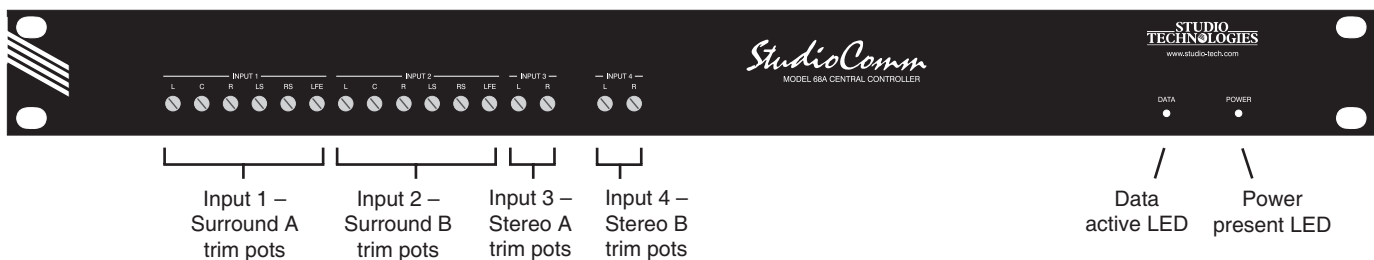
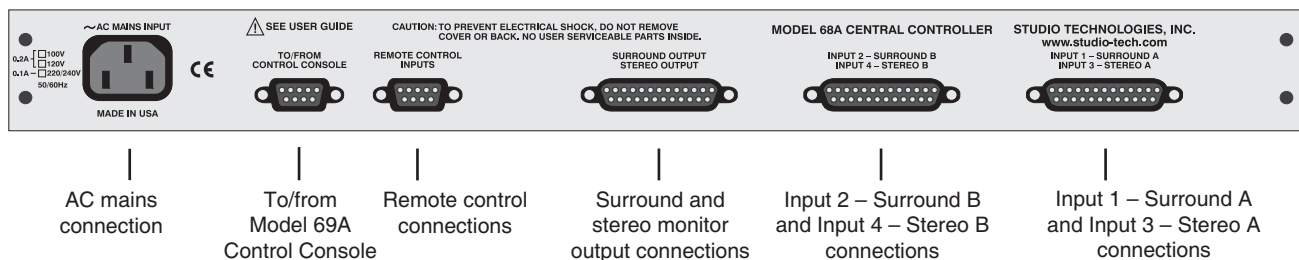

Figure 2. Model 68A Central Controller Back Panel



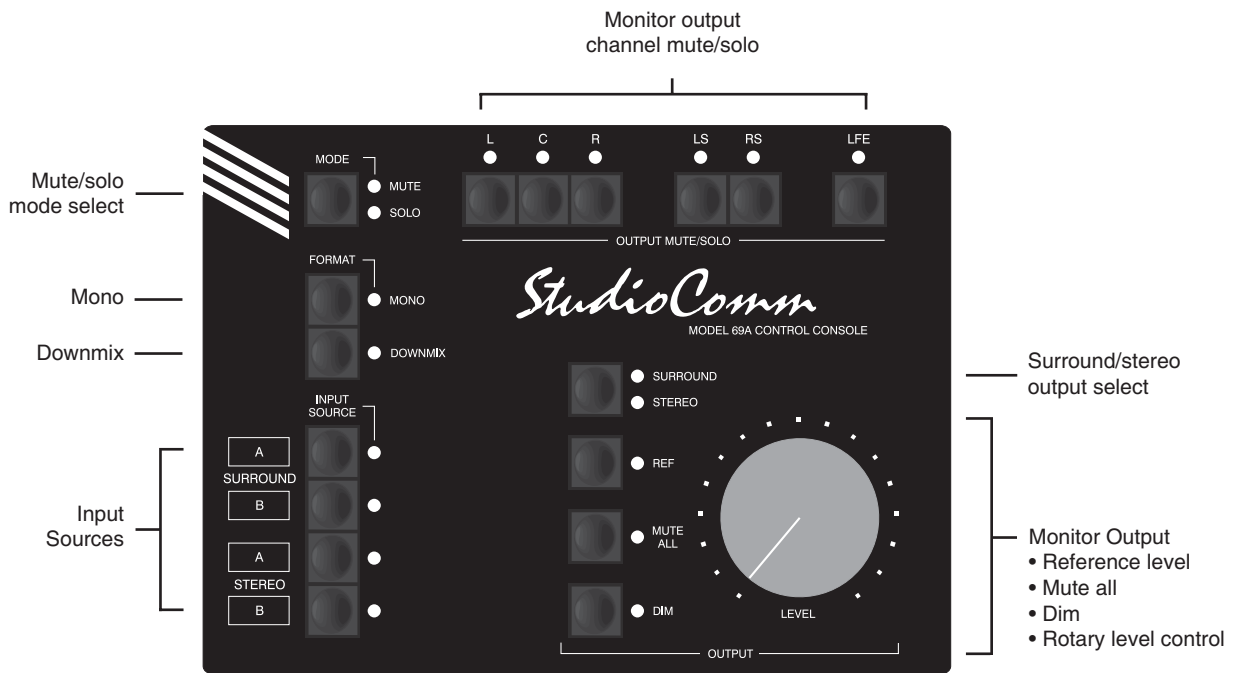

Figure 3. Model 69A Control Console Front Panel

Two functions allow the format of the monitored signals to be checked for level or phase inconsistencies. The downmix function is used to create a 2-channel stereo signal from a surround source. The mono function allows a stereo signal to be added (summed) and monitored by either the left channel and right channel monitor outputs, or the center channel monitor output. The downmix and mono functions can be enabled at the same time, allowing a surround signal to be checked for mono compatibility.

A bandpass filter can be inserted into the path of the mono signal when it is being routed to the center channel. This allows the simulation of the response of a loudspeaker associated with an inexpensive monaural television or portable radio.

A major strength of the Model 69A is the ability to configure, under software control, many operating parameters. This allows

operation to be tailored to meet the characteristics of an installation. In addition, the specific operating preferences desired by a facility or individual user are selected. To meet future needs, all configurations can be changed at any time. All configuration parameters are stored in non-volatile memory.

A Model 69A Control Console connects to the Model 68A Central Controller using a standard 9-pin D-sub cable. Power for the Model 69A is provided by the Model 68A. The Model 69A generates MIDI system-exclusive messages to control the Model 68A. Remote control signals, while physically connected to the Model 68A, route to the Model 69A via conductors in the 9-pin D-sub interconnecting cable.

Remote Control Capability

Three remote control functions are available: mute all, dim, and input select. Remote mute all and remote dim are

provided so that communications systems, machine control systems, or communication functions associated with audio consoles can easily be interfaced. Remote input select allows a machine control system or audio storage device to control which input source is selected for monitoring. Audio-post professionals will know this as PEC-Direct switching.

Limitations on Signal Routing

While the StudioComm Model 68A/Model 69A will do many wonderful things, it is not designed to selectively route input signals to the different monitor output channels. A fixed input-channel-to-output-channel relationship is maintained. A signal on the LFE channel of Surround B will, when selected, output only on the LFE channel of the monitor output. Any rerouting of the input signals must be done prior to connection to the StudioComm system. This should not be an impairment in most facilities, but it's important to highlight this fact.

Audio Channel Assignment

The designers of the StudioComm Models 68A and 69A made the decision to assign the audio channels in the order of left, center, right, left surround, right surround, and LFE. It was felt that this was a convenient, rational arrangement, common to many "5.1" installations and one that would fit the needs of most operators. However, not all formats follow this convention. Major audio companies such as Dolby Laboratories and DTS may use different channel assignment schemes in their release formats. It is hoped that careful interconnection of audio signals during installation, or incorporating routing flexibility using a patch bay, will mitigate any significant inconveniences.

Installation

In this section you will be installing the Model 68A Central Controller in an equipment rack. Audio input and monitor output connections will be made. A location will be selected for the Model 69A Control Console and it will be connected to the Model 68A. If required, external equipment will be interfaced to the remote control inputs. AC mains power will be connected to the Model 68A.

System Components

The shipping carton contains one each of the following: Model 68A Central Controller, Model 69A Control Console, 20-foot (6.1 m) 9-pin D-sub interconnecting cable, user guide, and warranty card. Units destined for North America also include an AC mains cord. Your dealer or distributor will provide an AC mains cord for non-North American destination.

Mounting the Model 68A

The Model 68A Central Controller requires one space in a standard 19-inch (48.3 cm) equipment rack. Select a location that is convenient to both the analog audio signals and the Model 69A Control Console. A 20-foot (6.1 m) cable is supplied to connect the Model 68A to the Model 69A. You can supply your own interconnecting cable, however 50 feet (15.3 m) is the recommended maximum length. Secure the Model 68A into the equipment rack using two mounting screws per side.

Audio Connections

Audio signal connections are made by way of three 25-pin D-sub connectors, located on the Model 68A's back panel. Three cable harnesses, each with a

25-pin D-sub plug (male) on one end and the desired connectors on the other end, are necessary. These cable harnesses are not supplied by Studio Technologies. Note that our friends in some locations may use the term “loom” instead of harness.

The wiring scheme used by the D-sub connectors comply with that made familiar by TASCAM® with their DA-88® product. Wiring harnesses prepared for connecting to the surround and stereo inputs are identical to DA-88-style input harnesses. A wiring harness prepared for the monitor outputs is identical to that of a DA-88-style output harness. Please refer to Figures 4, 5, and 6 for the exact connection details. Note that the Model 68A’s D-sub connectors use 4-40 threads.

Unless there’s a special need, it may be cost and time effective for you to purchase commercially made cable harnesses. Let the large market for DA-88-style cabling help you painlessly install your system!

Surround and Stereo Inputs

The connectors labeled Input 1 – Surround A & Input 3 – Stereo A and Input 2 – Surround B & Input 4 – Stereo B are used to interface with the input circuits. Please refer to Figures 4 and 5 for details on the exact “pin out” of the D-sub connectors. Each input circuit is electronically balanced, and is intended for connection to balanced or unbalanced sources with nominal signal levels of –12 dBV to +6 dBu. A 15-turn trim potentiometer is associated with each input, allowing the input sensitivity to be adjusted to match the source’s level. The configuration section of this guide provides details on using the trim pots.

Connections	Signal High (+)	Signal Low (-)	Shield
SURROUND A-L	24	12	25
SURROUND A-C	10	23	11
SURROUND A-R	21	9	22
SURROUND A-LS	7	20	8
SURROUND A-RS	18	6	19
SURROUND A-LFE	4	17	5
STEREO A-L	15	3	16
STEREO A-R	1	14	2

Notes: 1) Connector type on Model 68A is 25-pin D-subminiature female. Installer must provide plug (male). Connector uses 4-40 threaded inserts for locking with mating plug.

2) Wiring scheme follows TASCAM DA-88 convention. Standard DA-88-type wiring harnesses are directly compatible, with the exception of 4-40 screw threads being required.

Figure 4. Connections for Inputs Surround A and Stereo A

Connections	Signal High (+)	Signal Low (-)	Shield
SURROUND B-L	24	12	25
SURROUND B-C	10	23	11
SURROUND B-R	21	9	22
SURROUND B-LS	7	20	8
SURROUND B-RS	18	6	19
SURROUND B-LFE	4	17	5
STEREO B-L	15	3	16
STEREO B-R	1	14	2

Notes: 1) Connector type on Model 68A is 25-pin D-subminiature female. Installer must provide plug (male). Connector uses 4-40 threaded inserts for locking with mating plug.

2) Wiring scheme follows TASCAM DA-88 convention. Standard DA-88-type wiring harnesses are directly compatible, with the exception of 4-40 screw threads being required.

Figure 5. Connections for Inputs Surround B and Stereo B

Balanced sources should be wired so that signal high is connected to +, signal low to –, and shield to the shield connection. With an unbalanced source, connect signal high to the + connection, and shield to both the – and the shield connections. If connecting to an unbalanced source in this manner results in hum or noise, try connecting signal high to +, and shield to –; leave the shield connection unterminated.

It is highly recommended that at least one of the surround inputs be wired by way of an audio patch bay. This will allow the channels associated with that input source to be easily rerouted. While signals generated within a facility will normally follow a specific format, such as left, center, right, left surround, right surround, LFE, it is possible that media provided by an outside facility will follow a different one.

Monitor Outputs

The connector labeled Surround Output Stereo Output provides access to the 6-channel surround and 2-channel stereo monitor outputs. Please refer to Figure 6 for details on the exact “pin out” of the D-sub connector.

The monitor output channels are intended for connection to audio amplifiers associated with monitor loudspeakers, or to the inputs of loudspeakers that contain integrated amplifiers. The monitor outputs are electronically balanced and capable of driving balanced or unbalanced loads of 600 ohms or greater. While balanced operation is preferred, unbalanced operation does not pose a problem. To connect to an unbalanced load connect the + terminal as signal high, and both the – and shield as the signal low/shield. For optimal unbalanced operation, it is important to

Connections	Signal High (+)	Signal Low (–)	Shield
SURROUND OUT-L	24	12	25
SURROUND OUT-C	10	23	11
SURROUND OUT-R	21	9	22
SURROUND OUT-LS	7	20	8
SURROUND OUT-RS	18	6	19
SURROUND OUT-LFE	4	17	5
STEREO OUT-L	15	3	16
STEREO OUT-R	1	14	2

Notes: 1) Connector type on Model 68A is 25-pin D-subminiature female. Installer must provide plug (male). Connector uses 4-40 threaded inserts for locking with mating plug.

2) Wiring scheme follows TASCAM DA-88 convention. Standard DA-88-type wiring harnesses are directly compatible, with the exception of 4-40 screw threads being required.

Figure 6. Connections for Surround and Stereo Monitor Outputs

connect both – and shield together directly on the D-sub plug, not at the other end of the harness.

Note that while the Model 68A’s electronically balanced output circuits are capable of driving loads of 600 ohms or greater, the output level will drop slightly as the load impedance approaches 600 ohms. A 0.5 dB difference in output level can be expected as the load impedance changes from 10 k ohms to 600 ohms.

Remote Control Inputs

Support is provided for three remote control input functions: mute all, dim, and input select. The inputs use logic gates, “pulled up” to +5 V by way of resistors, which are active when brought to the logic low state. Inputs of this type are commonly referred to as GPI inputs. While the input circuitry is protected from over-current and static (ESD) discharge, care should be taken to

prevent nasty signals from reaching them. The inputs are active only when held in the low state; they can't be configured to change state ("latch") in response to a logic pulse.

The connector labeled Remote Control Inputs on the back panel of the Model 68A is used to interface with the remote control inputs. Refer to Figure 7 for exact connection details. Note that pin 1 (Shield) and pin 9 (Remote Control Common) are electrically identical. In addition to connecting to system common, they connect to the Model 68A's chassis and mains earth connection. For convenience, the shield of the interconnecting cable should be connected to pin 1 (Shield), while the return signals of the remote control sources should connect to pin 9 (Remote Control Common).

Note that although the remote control connections are physically made to the D-sub on the Model 68A's back panel, the remote control input circuitry is actually located in the Model 69A Control Console. Conductors in the cable linking the Model 68A to the Model 69A route the remote control signals to the actual input circuitry.

Pin	Signal
1	Shield
5	Remote Mute All
6	Remote Dim
7	Spare Remote Input
8	Remote Input Select
9	Remote Control Common

Notes: 1) Connector type on Model 68A is 9-pin D-subminiature female. Installer must provide plug (male). Connector uses 4-40 threaded inserts for locking with mating plug.

Figure 7. Connector Pin Out for Remote Control Inputs

Connecting the Model 68A to the Model 69A

A cable with 9-pin D-sub plugs (males) on each end is used to interconnect the Model 68A Central Controller with the Model 69A Control Console. A 20-foot (6.1-meter) cable is provided with each system. The connector labeled To/From Control Console on the back panel of the Model 68A is used to connect to the Model 69A.

Should a cable of different length be required, it should be wired in a one-to-one fashion for all 9 pins. Pin 1 carries signal common, and must be connected at both ends. A shield connection for the cable should be connected to pin 1 on the Model 68A's end. For best performance the cable generally should not exceed 50 feet (15.3 meter) in length. The reality is that a cable much longer in length should work correctly, as long as an excellent-quality cable is utilized. We define "excellent" as extensive shielding along with very low capacitance. The low cable capacitance is important as it limits the amount of data-signal waveform distortion. As far as an actual maximum length, just test and see how far away you can go—if it works, it works!

AC Mains Power

The Model 68A is internally configured to operate from either nominal 100, 120, or 220/240 V, 50/60 Hz. Units shipped to North America are factory selected for 120 V operation. Units bound for Japan must be selected for 100 V, while our friends "down under" and in Europe receive units set for 220/240 V. Before connecting the Model 68A to AC mains power, check that it is configured to match the local mains voltage. Look on the back

panel (adjacent to the power entry connector) for the factory-configured voltage. Note that an incorrect configuration could prevent operation, or cause damage to the unit. Should it be necessary to change the unit's operating voltage it must be performed only at the factory or by an authorized service technician.

The Model 68A uses an IEC-standard connector to mate with the AC mains cord. The wire colors in the AC mains cord should conform to the internationally recognized CEE color code and must be wired accordingly:

<u>Connection</u>	<u>Wire Color</u>
Neutral (N)	Light Blue
Line (L)	Brown
Protective Earth (E)	Green/Yellow

Safety Warning: The Model 68A does not contain an AC mains disconnect switch. As such, the AC mains cord plug serves as the disconnection device. Safety considerations require that the plug and associated outlet be easily accessible to allow rapid disconnection of AC mains power should it prove necessary.

As soon as AC mains power is applied, the Model 68A's power present LED will light. The Model 69A will go through a power-up sequence, lighting each LED in succession. The data active LED on the Model 68A will briefly light upon completion of the Model 69A's power-up sequence.

Configuration

After the physical installation has been completed, several configuration issues must be addressed. On the Model 68A the surround and stereo inputs must be calibrated using the trim potentiometers. The operating parameters of the system should be set using the Model 69A Control Console's configuration mode.

Level Calibration

Sixteen 15-turn trim potentiometers are located on the front panel of the Model 68A Central Controller. Taking time to carefully adjust the trim pots will ensure that accurate monitoring can take place. Each trim pot allows input signals with a nominal level of -12 dBV to $+6$ dBu to be utilized. With care, it's easy to calibrate the surround and stereo inputs to within one-quarter of a dB of the desired value.

The monitor outputs are used as the measuring point when adjusting the trim pots. A laboratory-grade audio level meter, or equivalent, is required for accurate calibration. In addition, the audio sources connected to the inputs must be able to generate continuous audio signals at their nominal operating level.

Procedure

This procedure will calibrate the surround and stereo input channels. The trim pots will be adjusted in groups corresponding to their associated input sources.

1. Begin by turning the audio amplifiers or amplified speakers to their off state. This will protect the loudspeakers and the operator's ears from possible damage.

2. Rotate the level control on the Model 69A to the fully clockwise (maximum) position.
3. Using the Model 69A Control console, select Surround A as the input source and Surround as the selected monitor output.
4. On the Model 68A, connect the audio level meter to the left channel of the surround monitor output.
5. Confirm that the audio source's left channel is generating a steady signal at precisely its reference level.
6. Observing the level meter, adjust input 1, trim pot L, to give a precise +4 dBu level at surround monitor output L.
7. Disconnect the level meter from the left channel of the surround monitor output.
8. Repeat steps 4-7 for the center, right, left surround, right surround, and LFE channels of Surround A.
9. Repeat steps 3-8 for Surround B, Stereo A, and Stereo B. Obviously, the stereo inputs have only left and right inputs, requiring only that two trim pots be adjusted for each.
10. Rotate the level control on the Model 69A to the fully counterclockwise (minimum) position.
11. After ensuring that the Model 69A's level control is set to minimum, return AC mains power to the power amps or amplified speakers.

Model 69A Operating Parameters

Many StudioComm functions can be configured to meet the exact needs of your installation. Here's an overview of what you can configure:

- Input channels active
- Stereo output
- Solo mode
- Power-up mute all
- Level control response
- Level control auto mute all
- Reference level
- Remote control inputs
- Dim level
- Auto dim off
- Mono

The Model 69A configuration diagrams, located at the end of this section, give details on how each parameter is set. An overview of each configurable parameter is provided in the following paragraphs.

Entering and Exiting the Configuration Mode

A small button is located on the back of the Model 69A Control Console, adjacent to the 9-pin D-sub connector. Pressing and holding this button for two seconds places the Model 69A into the configuration mode. In the configuration mode the Model 69A's array of buttons and LEDs no longer perform their normal functions, but instead allow you to observe and change many of the operating parameters. The mute/solo mode LEDs light alternately to indicate that the configuration mode is active.

To leave the configuration mode and return the Model 69A to normal operation, once again press and hold the configure button for two seconds. Note that configuration changes are stored only after the configuration mode has been exited.

Our apologies to those of you who find the configure button a pain to use, but it's supposed to be that way! Seriously, the top of the button is slightly recessed from the back panel, making it harder to accidentally activate. We didn't want normal operation to cease because someone pushed the Model 69A into a "rats nest" of music scores or track sheets!

There is no problem frequently "tweaking" the Model 69A's operating parameters to achieve the desired performance. The configuration data is stored in non-volatile memory, which is rated for thousands of read and write cycles and a retention time in tens of years.

Input Channels Active

This configuration is a bit tricky to understand, but is really quite simple. The configuration parameter for the number of channels active for each input is provided for those special cases where a source has less channels than its usual, e.g., less than six for Surround A or B.

Let's look at an example. Surround A is connected to a 6-channel source, so its default configuration is fine. But the source for Surround B is special, having only three channels: left, center, and right. This makes it not so "cool" for the operator to select Surround B for monitoring, as the unconnected left surround, right surround, and LFE channels will get routed to their respective monitor outputs. Will the unused input channels pick up significant

noise or hum? Unlikely, but why take a chance at having a problem. Simply use the input channels active configuration to disable the three unused channels. Now when Surround B is selected, only the relevant channels are selected for monitoring.

Note that when a channel associated with an input is disabled, the input routing circuitry, under software control, no longer selects it, but the corresponding monitor output channel does not mute. With our example, when selecting Surround B, our mythical L/C/R source, all monitor output channels will remain active, but the input routing circuitry won't select the LS, RS, and LFE inputs. While to some people this might seem confusing and possibly a design fault, it was implemented this way because the StudioComm system allows multiple inputs to be simultaneously selected for monitoring; a surround source might be selected at the same time as a stereo source. Muting the outputs simply would not do!

A special mode has been included to allow an input to be disabled from being accessed by the operator. This might be useful, for example, when Stereo B is not connected to a source, and has no valid reason to be selected. This might also be useful when connecting a special source, such as a house "tie line" or router output, that shouldn't normally be accessible. To disable an input is simple, just disable all channels associated with it; six for Surround A and B, two for Stereo A and B. To confirm that an input has been disabled, all LEDs associated with that input will flash on and off. Once the Model 69A is returned to the normal operating mode, the disabled input cannot be selected.

Stereo Output

In addition to a 6-channel surround monitor output, a separate 2-channel stereo output is also provided. Two configurable parameters related to the stereo output are provided. The first parameter selects whether the stereo output can be enabled. By default the stereo output can be enabled by an operator. In applications where stereo monitor loudspeakers are not connected to the stereo output, the stereo output can be disabled. This can minimize confusion, preventing an operator from attempting to select the stereo output.

The second configurable parameter may seem a bit confusing, but could prove useful for special applications. By default, when an operator switches from the surround output to the stereo output, only the left and right channel connection associated with the stereo output will be active; all six of the surround monitor output channels will mute. But it's possible that surround output channels C, LS, RS, and LFE may need to remain active when the stereo output is active. The stereo output configuration function allows these channels to be individually enabled as required.

Solo Mode

Solo operation can be configured to satisfy operator preference. The additive solo mode matches the functionality found in most recording consoles. In this mode, multiple channels can be simultaneously "soloed," allowing those channels to be monitored at the same time. Other operators may prefer the exclusive solo mode. When this mode is selected, only one channel can be selected for solo at a time. The additive solo mode is the default setting.

Power-up Mute All

By default, upon application of AC mains power the monitor outputs remain muted after the system's power-up sequence has been performed. Then an operator must manually press the mute all button to enable the monitor outputs. There may be cases where having the monitor output channels return to their respective states as left at the time of the previous loss of AC mains power, allowing normal operation automatically to resume.

Level Control Response

As expected, the level control on the Model 69A Control Console is used to adjust the output level of the monitor output channels. The amount of rotation required to reach a specific level can be selected. This can be described as allowing the "curve" or "taper" of the level control to be configured. Two choices are available: true logarithmic and modified logarithmic. In the true logarithmic mode the level control provides a precise logarithmic performance over its entire rotation, e.g., the output level is half of its maximum when the control is set at its midpoint, i.e., 50% of its "travel." In the true log mode, normal listening may require the level control to be set to approximately the "2-o'clock" position. Users of Studio Technologies' Models 59 and 69 Control Consoles have experienced this level control performance. To reproduce this with the Model 69A, select true logarithmic.

Other users may be more comfortable with the response given by the modified logarithmic mode. This provides a much greater output level during the first 50% of the level control's travel. When configured for the modified log mode, normal listening may require the level control to be set to

the 11- or 12-o'clock position. The modified log mode more closely matches the monitor level control performance found in many audio consoles. As such it is selected as the default mode.

It's important to note that changing the level control response configuration will impact the reference level. Changing from modified log to true log, or vice-versa, will change the reference level. Technically, the mathematical value stored as the reference level does not change, but the loudness that is heard by the operator will change. Be warned! Changing the level control response may require the reference level to be recalibrated.

Level Control Auto Mute All

The level control auto mute all function automatically mutes the monitor output channels whenever the rotary level control is in its fully counterclockwise position. In some applications it may be desirable to disable this function. When disabled, the rotary level control adjusts the monitor output level over the approximately 72 dB range; no automatic muting takes place.

Reference Level

For audio-with-picture applications it's critical that mixing be done in reference to a known monitor loudspeaker level. This is often referred to as mixing to "85 dB" on the monitors. The Model 69A Control Console allows a precise monitor output level to be stored, and then enabled by pressing the button labeled REF. Setting the reference level is very simple:

1. Set up a precision sound pressure level (SPL) measuring device at the desired listening location.
 2. Place the StudioComm system in the normal operating mode, not the configuration mode. Be certain that the reference and dim functions are not active.
 3. Use the Model 69A Control Console to select the input source that contains the desired reference signal source, e.g., pink noise.
 4. Select the desired output, surround or stereo.
 5. Observing the SPL meter, adjust the Model 69A's rotary level control until the desired reference output level has been reached.
 6. Being careful not to touch the position of the rotary level control, enter the configuration mode by pressing and holding the configuration button located on the Model 69A's back panel.
 7. Once the configuration mode has been entered, the monitor outputs will mute. Press and hold the reference button until its associated LED lights. This will take approximately 5 seconds. The LED will light to indicate that a "snapshot" of the new reference level has been taken.
 8. To store the new reference level in memory, exit the configuration mode by again pressing and holding the configure button.
- This level is now permanently stored as the reference level. Only by repeating the procedure can the value be changed.
- Once the configuration mode has been exited, the monitor output channels will again become active. Confirm that the correct level has been stored by pressing the reference button. The SPL meter should

again display the desired level. If not, repeat the calibration procedure.

You might wonder why you have to press and hold the reference button for 5 seconds before the selected value is stored. This is provided specifically so that some turkey won't accidentally change the reference level while they are playing around in the configuration mode! Only if you know the "secret" will you be able to store a new value.

Remote Input Select

The remote input select function requires configuring two parameters: mode and input to be selected. The mode can be selected from three choices: disabled, exclusive, and non-exclusive. As expected, when configured for disabled, the function can not be activated. When configured for exclusive, whenever the function is activated only the specified input will be active. When configured for non-exclusive, whenever the function is activated the specified input will be added (summed) with any other input or inputs that are already active.

Remote Mute All

Two configuration choices are associated with the remote mute all function: disabled and enabled. To utilize the function simply configure it for enabled.

Remote Dim

Two configuration choices are associated with the remote dim function: disabled and enabled. To utilize the function simply configure it for enabled.

Spare Remote Input

This remote control input is reserved for future use. Enabling or disabling this input will not impact system performance.

Dim Level

The dim function is used to reduce the monitor output level by a preset amount. The reduction is in dB relative to the monitor output's current level. There are four dim level values available: 10, 15, 20, and 25 dB.

Auto Dim Off

The auto dim off function is unique, making the dim function respond to real world operating conditions. When enabled, the function automatically turns the dim function off if a change is made to the control room level potentiometer while the unit is already in dim mode. This prevents a heart-stopping blast of audio when an engineer presses the dim button to turn dim on, but actually turns it off because the unit was already in the dim mode. While it's hard to explain unless you've used a console and experienced this in person, trust us, this situation does happen! Auto dim off is a wonderful "real-world" function and in most cases should be enabled.

Mono Mode

The mono operating mode can be selected from two choices: mono-to-left-and-right or mono-to-center. For music mixing it's common to have a mono function combine (sum) the signals from the left and right channels and route the result to both the left and right output channels. For broadcast and cinema use, it may be more appropriate to combine the left and right signals and route the result to the surround output's center channel. By default mono is set to the mono-to-center mode.

Mono Attenuation

To meet the needs of the operator and specific program content, an attenuation

level when mono is active can be configured. The choices are 0, 3, 4, and 6 dB. Selecting 0 dB is equivalent to the attenuation function being disabled, resulting in no attenuation when mono is selected. This is provided for those special cases when the mono mode is set to mono-to-center and no phase coherent signals are expected to be part of the left and right channels. Not generally appropriate for music mixing, it may find use in broadcast and cinema applications. 3 dB and 4 dB are good choices for the mono-to-center mode when monitoring mixes that have significant phase coherence, such as music sources. 6 dB is provided for compatibility with the mono function found on many audio consoles. As the factory default, an attenuation value of 3 dB was selected.

Auto Downmix

The downmix function can be configured to automatically enable whenever the mono function is enabled. This is provided to ensure accurate monitoring of surround sources when mono is enabled. This is the default mode, although it can be changed as desired.

Restore Factory Defaults

The restore factory defaults function is provided primarily for factory use. In this way a system can be shipped with the default settings selected. While you are welcome to use this function, be careful so that your configuration efforts aren't wasted. Specifically, be aware that the reference level is reset to minimum level. All the other parameters are fairly easy to set up, but resetting the reference level would require getting out an SPL meter and a calibrated signal source. This is a hassle you may not need!

Model 69A Configuration—Entering and Exiting Configuration Mode



Press and hold the configuration button for 2 seconds to enter or exit the configuration mode.

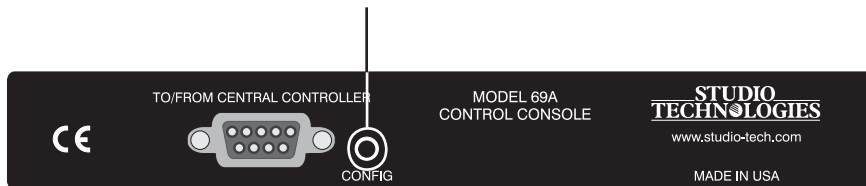

These LEDs will light alternately when configuration mode is active.

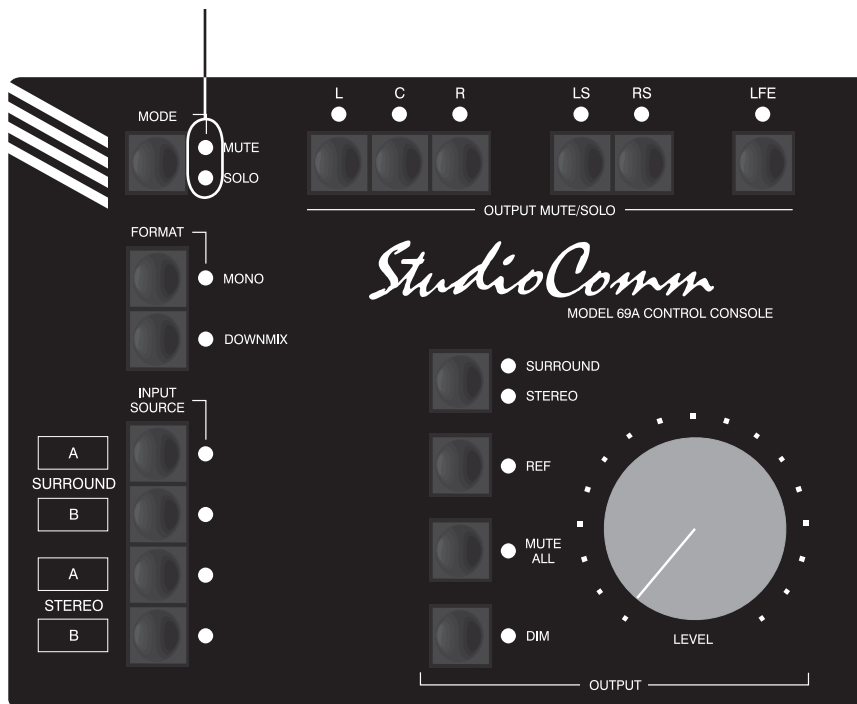

Model 69A Configuration—Input Channels Active



Press and hold an input button (one at a time) to display and select which channels associated with that input are active.

When an input button is pressed, these LEDs display which input channels are active for that input. A lit LED indicates that the channel is active. Use the buttons to change the configuration.

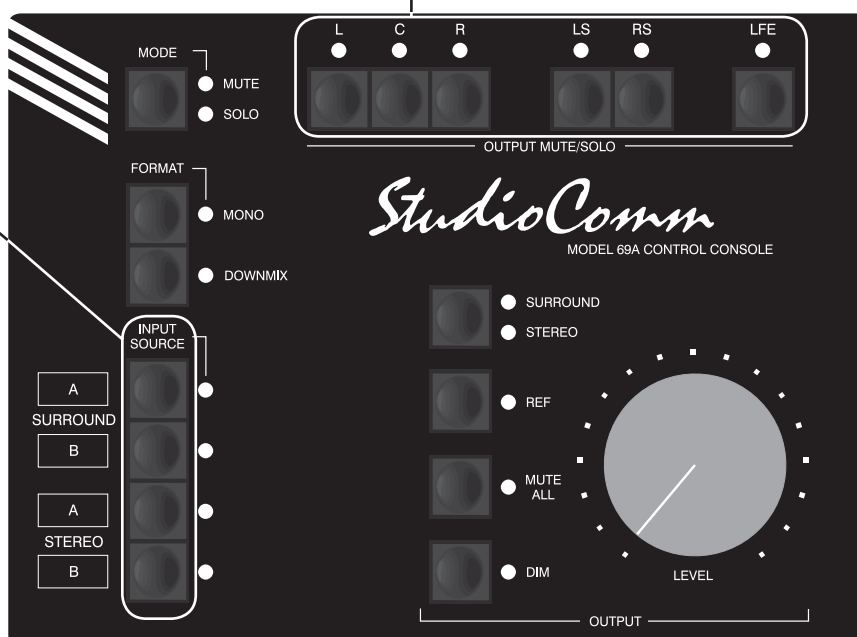

Default: For Surround A and Surround B, all six channels (L, C, R, LS, RS, LFE) are active. For Stereo A and Stereo B, both channels (L, R) are active.

Note: A special input disable function is available. By disabling all channels associated with a specific input, that input will no longer be available during normal operation. While in the configuration mode, all LEDs associated with an input will flash to indicate that the input has been disabled. This function is useful if an input is not going to have a source associated with it. Then during normal operation this input cannot be selected, minimizing any confusion caused by selecting an invalid input source.

Model 69A Configuration—Stereo Output



Press and hold the Mode button to display and configure whether the stereo output can be enabled and which surround monitor output channels are active when the stereo monitor output is enabled.

When the Mode button is pressed, these LEDs display whether surround monitor output channels C, LS, RS, and LFE are active when the stereo output function is enabled. A lit LED indicates that the channel is active. Use the buttons to change the configuration.

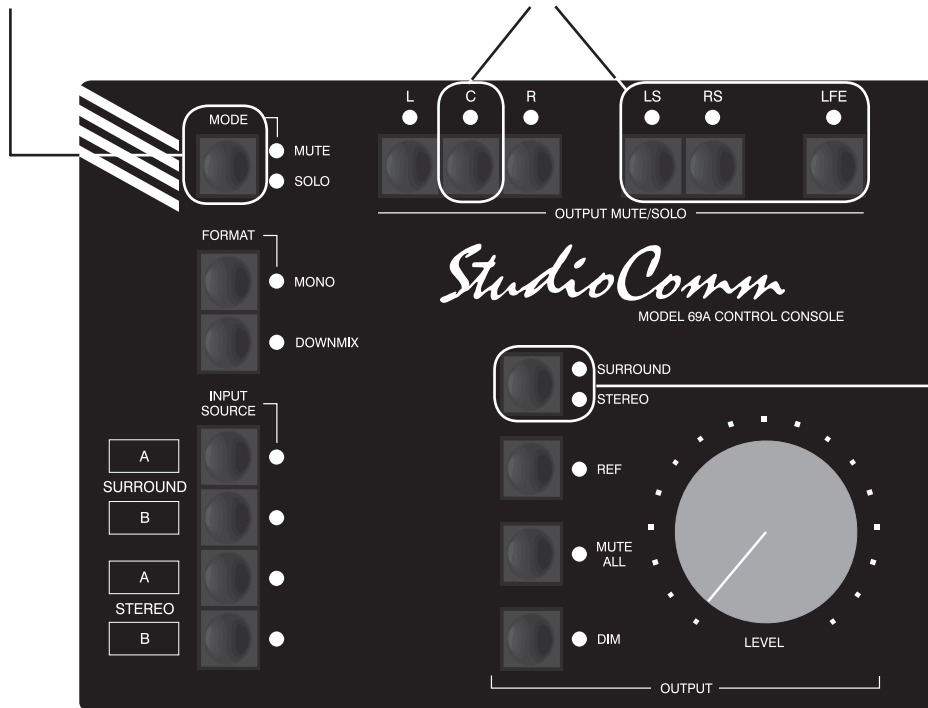

When the Mode button is pressed, these LEDs display the status of the stereo output function. When LED Surround is lit the stereo output function cannot be enabled. When LED Stereo is lit the stereo output function can be enabled. Use the button to change the configuration.

Default: Stereo output can be enabled.
Surround output channels C, LS, RS, and LFE not active when stereo output enabled.

Model 69A Configuration—Solo Mode, Power-Up Mute All, Level Control Response, and Level Control Auto Mute All

When the Surround/Stereo button is pressed, these LEDs display the status of the solo mode. When LED L is lit additive solo mode is enabled; when LED C is lit exclusive solo mode is enabled. Use the buttons to change the configuration.

When the Surround/Stereo button is pressed, these LEDs display the status of the power-up mute all function. When LED R is lit the state of mute all is saved at power down and followed upon power up; when LED LS is lit the system is always in mute all upon power up. Use the buttons to change the configuration.

When the Surround/Stereo button is pressed, these LEDs display the status of the level control response mode. When LED RS is lit the level control provides a true logarithmic response. When LED LFE is lit the level control provides a modified logarithmic response. Use the buttons to change the configuration.

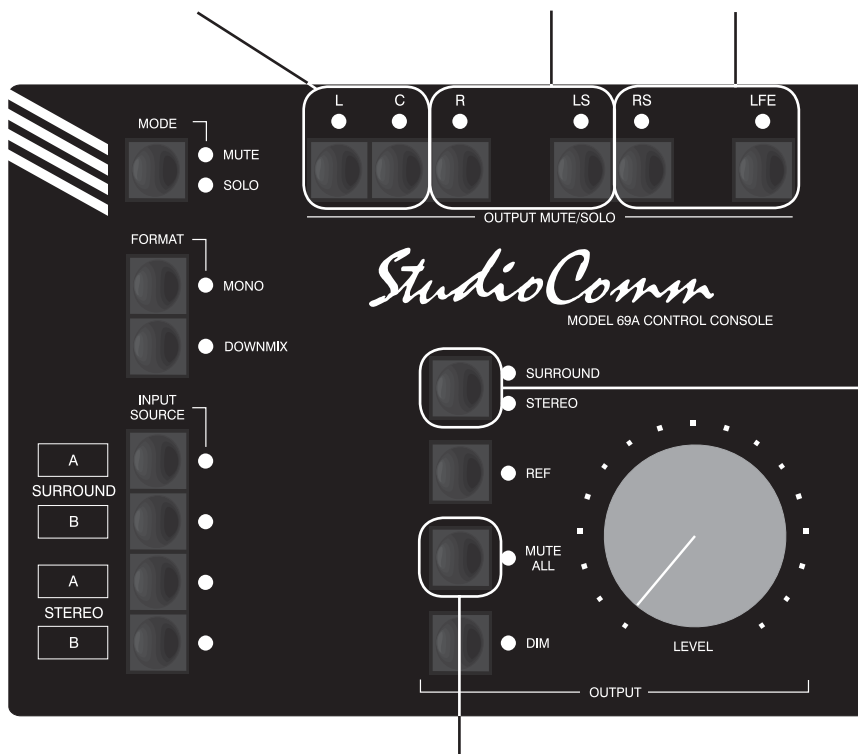

Press and hold the Surround/Stereo button to display and select the status of the solo mode, power-up mute all function, level control response mode, and level control auto mute all function.

Press and hold the Surround/Stereo button to display and select the status of the level control auto mute all function. When the LED is lit the function is enabled. Use the button to change the configuration.

Default: Additive solo mode enabled.
 Upon power up, mute all function enabled.
 Level control provides modified logarithmic response.
 Level control auto mute all function enabled.

Model 69A Configuration—Reference Level

 Press and hold the Ref button for 5 seconds to take a “snapshot” of the level control’s present setting. The Ref LED will light when the “snapshot” has been taken.

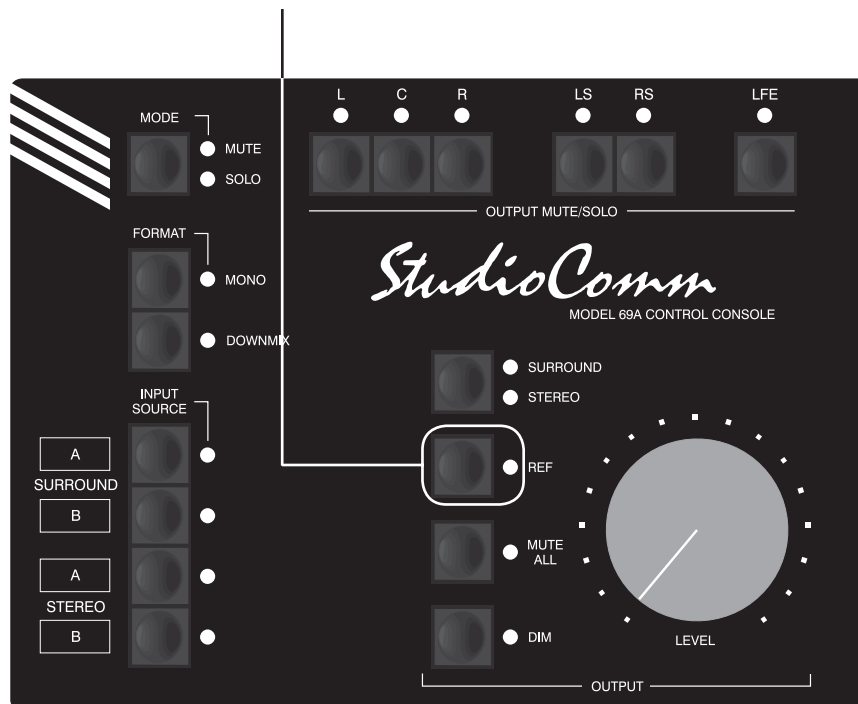

Default: Fully attenuated (minimum) monitor output level.

Note: The 5-second delay is a safety feature, ensuring that the reference level will not be accidentally changed. To permanently store the new value, you must still exit the configuration mode.

Model 69A Configuration—Remote Input Select

These LEDs display the mode of the remote input select function. LED L lit means that the function is disabled. LED C lit means that the function provides exclusive input select. LED R lit means that the function provides non-exclusive input select. Use the buttons to change the configuration.

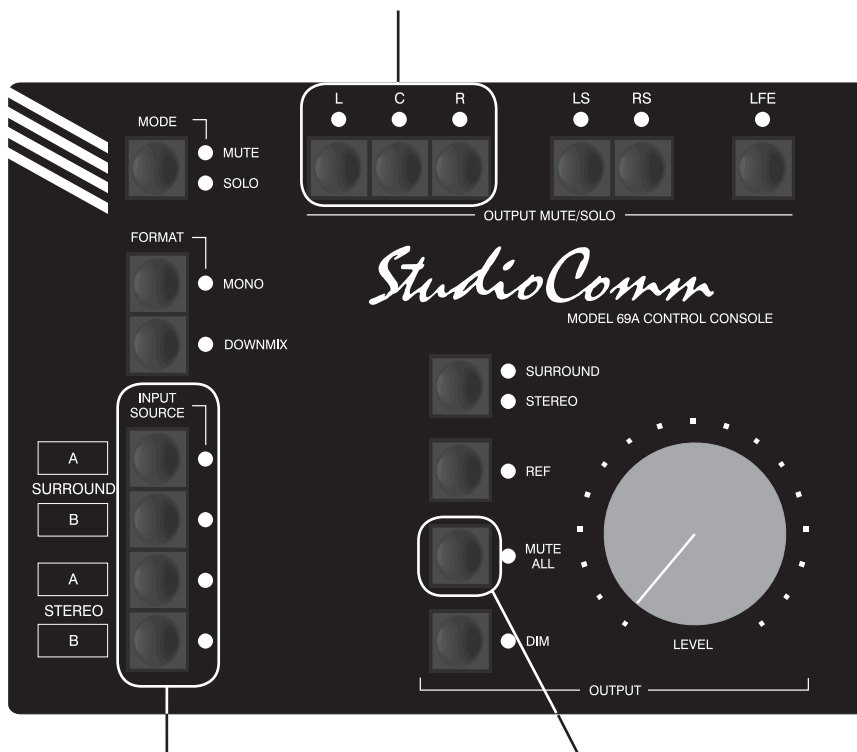

When the Mute All button is pressed, these LEDs display the input associated with the remote input select function:

LED Surround A lit means Surround A;
LED Surround B lit means Surround B;
LED Stereo A lit means Stereo A;
LED Stereo B lit means Stereo B.

Use the buttons to select the input.

 Press and hold the Mute All button to display and configure the remote input select function.

Default: Remote input select function disabled.
Surround A associated with remote input select function.

Model 69A Configuration—Dim Level, Remote Mute All, Remote Dim, Spare Remote Input, and Auto Dim Off

These LEDs display the configuration of remote mute all. LED L lit means that remote mute all is disabled; LED C lit means enabled. Use the buttons to change the configuration.

These LEDs display the configuration of remote dim. LED R lit means that remote dim is disabled; LED LS lit means enabled. Use the buttons to change the configuration.

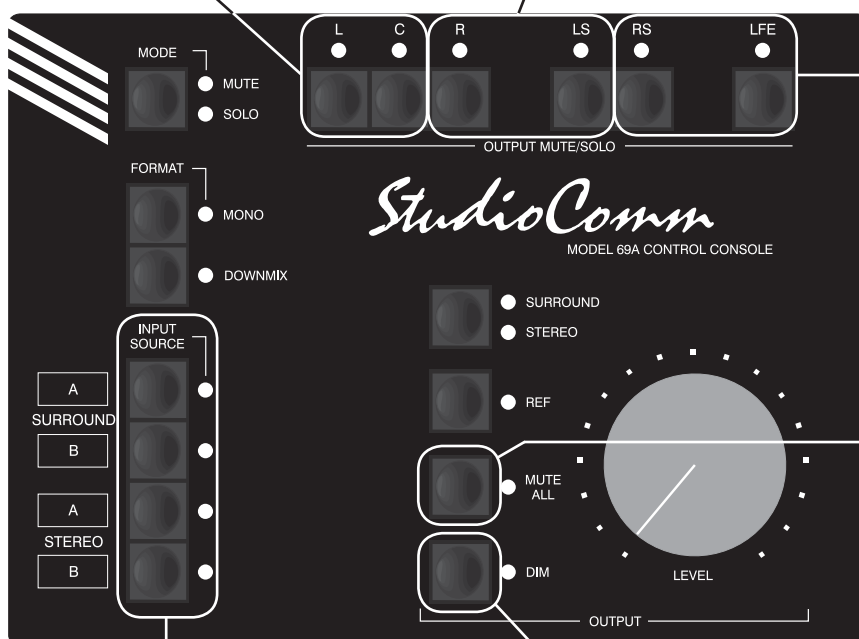

These LEDs display the status of the spare remote input. LED RS lit means that the input is disabled; LED LFE lit means the input is enabled. Use the buttons to change the configuration.

Press Mute All to toggle the automatic dim off function; LED on means auto dim off function is active.

When the Dim button is pressed, these LEDs display the selected dim level:

LED Surround A lit means 25 dB dim;
LED Surround B lit means 20 dB dim;
LED Stereo A lit means 15 dB dim;
LED Stereo B lit means 10 dB dim.

Use the buttons to select the dim level.



Press and hold the Dim button to display and select the dim level, remote mute all, remote dim, spare remote input, and auto dim off configurations.

Default: 20 dB dim level.
Remote mute all disabled.
Remote dim disabled.
Spare remote input disabled.
Auto dim off enabled.

Model 69A Configuration—Mono

 Press and hold the Mono button to display and configure the mono mode, whether downmix is automatically activated when mono is activated, and the attenuation level when mono is active.

When the Mono button is pressed, these LEDs display the mode of the mono function. When LED L is lit the mono-to-left-and-right mode is selected. When LED C is lit the mono-to-center mode is selected. Use the buttons to change the configuration.

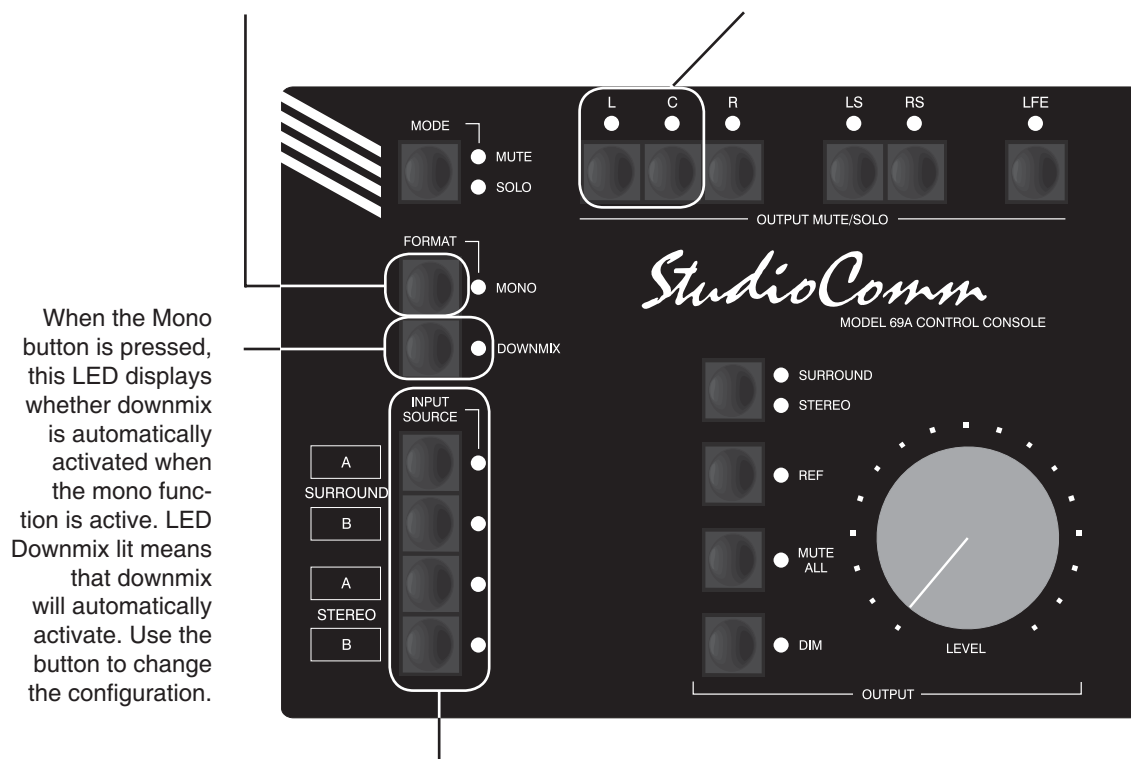

When the Mono button is pressed, these LEDs display the attenuation level when mono is active:

LED Surround A lit means 6 dB;
LED Surround B lit means 4 dB;
LED Stereo A lit means 3 dB;
LED Stereo B lit means 0 dB.

Use the buttons to select the attenuation level.

Default: Mono mode: mono-to-center.
3 dB attenuation when mono is active.
Downmix automatically activated when mono activated.

Model 69A Configuration—Restore Factory Defaults

 Press and hold both Surround A and Stereo B buttons for 5 seconds to restore Model 69A factory defaults. Once defaults have been restored, the LEDs will light. After buttons are released, configuration mode will be exited and normal operation will resume.

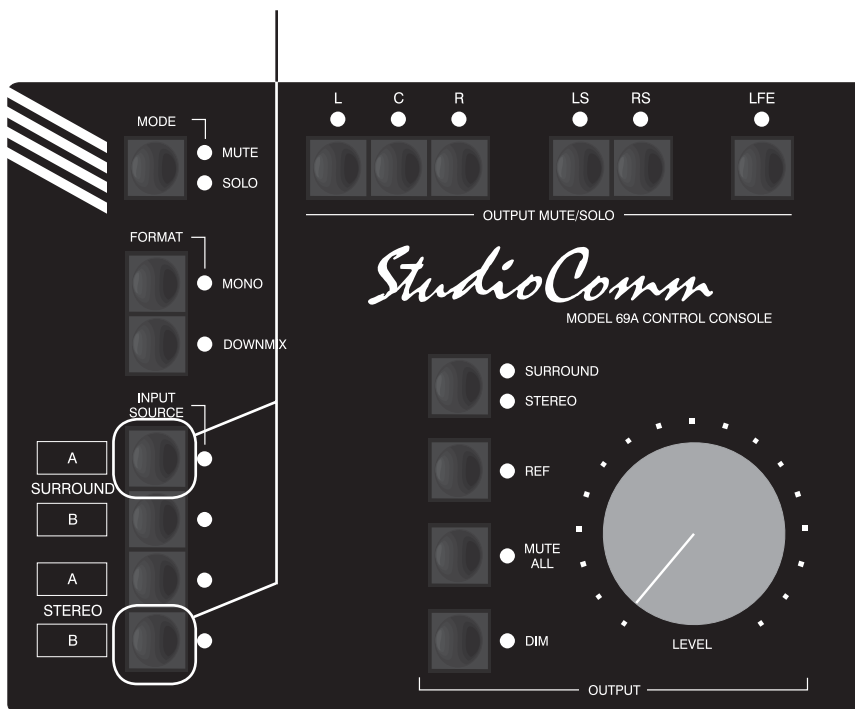

Factory Defaults: All channels associated with each input are active.
Stereo output can be enabled.
Surround output channels C, LS, RS, and LFE not active when stereo output enabled.
Additive solo mode enabled.
Upon power up, mute all function enabled.
Level control operates modified logarithmic.
Level control auto mute all function enabled.
Reference level is set for fully attenuated (minimum) monitor output level.
Remote input select function disabled.
Surround A associated with remote input select function.
20 dB dim level.
Remote mute all disabled.
Remote dim disabled.
Spare remote input disabled.
Mono mode: mono-to-center.
3 dB attenuation when mono active.
Downmix activated when mono activated.

Note: The 5-second delay is a safety feature, ensuring that the factory defaults will not be accidentally restored.

Operation

Now that you've installed and configured the system, you're ready to go. You should find operation very easy.

Model 68A Central Controller

The Model 68A's front panel contains two LEDs. The power LED should be lit whenever AC mains power is connected. The data LED will light whenever a MIDI system-exclusive message is received from the Model 69A.

Model 69A Control Console

StudioComm operation is controlled using the Model 69A Control Console and, if connected, the remote control inputs. To make things easy to describe, we've divided the StudioComm functions into five main groups: input source selection, format, monitor output general functions, mute/solo, and remote controls.

Input Source Selection

Input source selection is simple. To select an input source for routing to the monitor outputs, press one of the four input source buttons. The corresponding LED will light to let you know that the input has been selected. You can select more than one input source simultaneously; up to all four. The selected inputs will be summed (combined). Start by pressing and holding the button associated with your first input source. While the button is still pressed, add the extra inputs by momentarily pressing the buttons associated with them. The LEDs will light to tell you which inputs have been selected.

A recall feature is an integral part of the input selection process. It's a bit confusing

to explain, but simple once you experience it in "real time." A one sentence explanation would describe the input recall feature as allowing the system to return to the previously selected input (or inputs) by simply pressing one button. It was included specifically for film-post applications where it's important to be able to change quickly between a combination of inputs, such as two "stems," and a single input.

Let's begin the explanation with an example: A film-post facility where the usual monitoring setup has both Surround A and Surround B simultaneously selected, while Stereo A is occasionally selected to monitor a cue track. To select both inputs, press and hold the button associated with Surround A, then press Surround B's button, then release both buttons. Surround A and Surround B are now selected for monitoring. To monitor Stereo A press the button associated with it. To return to monitoring Surround A and Surround B, simply press Stereo A's button again. The recall feature has returned the system to the previously selected inputs. That's all there is to it!

A special configuration mode allows an input to be disabled. This would be appropriate if an input is not connected to an audio source. If you press an input source button and the previously selected input source does not change, the newly selected input has been disabled.

Format

The downmix and mono functions allow an operator to perform "real world" compatibility checks. They are referred to as format functions because they allow conversion between various audio formats, e.g., surround signals converted to stereo;

stereo signals converted to mono. How these functions affect the audio signals will greatly depend on how the Model 69A is configured. Being aware of the selected configuration will allow the functions to serve a more useful role.

Downmix

The downmix function allows surround signals to be mixed or “folded down” into a stereo (left and right) signal. Phase relationships and inter-channel level issues can be quickly observed. Please refer to the Technical Notes section of this guide for a detailed description of how the downmix function mixes surround to stereo.

Using the downmix function simply requires the downmix button to be pressed. The downmix button is always set to “latch” the function on and off. The associated LED lights when downmix is enabled. The stereo signal created by the downmix function is routed to the left and right channels of the surround or the stereo output, depending on which is active.

Depending on how the Model 69A Control Console is configured, the downmix function may automatically enable whenever the mono function is enabled. This is provided to ensure an operator hears a valid mono signal when a surround source is selected as an input.

Mono

The operating characteristics of the mono function depend on the Model 69A Control Console’s configuration. Two mono modes are available, as are four attenuation levels. In the mono-to-left-and-right mode the function combines (sums) the signals on the left and right channels and routes the result to both the left and right monitor output channels. This method is the same

as found on many stereo-oriented audio consoles. Useful for music mixing, it’s not true monaural but rather binaural. As expected, the mono signal will be routed to the left and right channels of either the surround or the stereo monitor output, depending on which output is selected by way of the surround/stereo button.

In the mono-to-center mode the mono function combines (sums) the left and right channels and routes the result to the center channel of the surround output. This function allows a more accurate reproduction of a mono signal, but may not be suitable for all operators. As expected, in the mono-to-center mode the mono signal will always be routed to the surround center channel, no matter whether the surround or the stereo output is selected by way of the surround/stereo select button.

To enable the mono function simply requires the mono button to be pressed. The mono function is always set to “latch” the function on and off. The associated LED will light whenever mono is enabled.

Bandpass Filter for Mono-to-Center Mode

A special feature has been included to assist an operator in determining compatibility with “real world” playback environments. A bandpass filter can be inserted into the path of the mono signal when it is being routed to the center channel. This allows the simulation of the response of a loudspeaker associated with an inexpensive monaural television or portable radio. The filter passes signals in the range of 100 Hz to 5 kHz, while rejecting those above and below.

To highlight for clarity, the bandpass filter is only available for use when mono has

been configured for the mono-to-center mode. For a detailed technical description of the bandpass filter please refer to the Technical Notes section of this guide.

To enable the bandpass filter feature requires knowing a “secret” button push method. But it’s not much of a secret, as you simply press and hold the mono button for two seconds to enable the function. From that point forward, whenever mono is enabled the bandpass filter will also be enabled. To indicate that the bandpass filter is enabled, the LED associated with the mono button will flash on and off whenever mono is enabled. To disable the bandpass function, press and hold the mono button for two seconds. The change will be indicated by the LED, which will now light steadily whenever the mono function is enabled.

Monitor Output General Functions

Four buttons and one rotary control are associated with the monitor output functions. The buttons control operation of surround and stereo outputs, reference level, mute all, and dim. The rotary level control is used to manually set the monitor output level.

Surround and Stereo Outputs

The surround/stereo function allows selection between two different loudspeaker systems. When the surround output is selected the six surround output channels are active. The two channels associated with the stereo output are muted. When the stereo output is selected the left and right channels associated with the stereo output become active; the left and right channels of the surround output mute.

In most cases surround output channels center, left surround, right surround, and LFE will also mute. However, a configurable parameter does allow these channels to remain active when the stereo output is selected. There are two LEDs associated with the surround/stereo button, providing a visual display of the active output.

Remember that the Model 69A Control Console can be configured to disable the surround/stereo button. If the button is pressed and nothing happens, this must be the case!

Reference Level

The reference level button, labeled REF, sets the monitor output level to a preset value. This level is normally set by a technician, using a sound-pressure-level (SPL) meter, at the time of system installation. The LED associated with the reference level function lights whenever the function is active. Whenever reference level mode is active the rotary level control is disabled.

The reference LED also serves as a calibration aid. If the reference level mode is not active, and the rotary level control is set at precisely the same level as that stored for the reference value, the reference LED will flash.

Mute All

The mute all function is highly complicated to operate—not! Pressing the mute all button causes the monitor outputs to mute. The mute all button is always set to “latch” the function on and off. The LED associated with the mute all button will light whenever mute all is active. Note that if mute all is enabled via the remote mute all function, the mute all LED will flash.

Dim

The dim function is quite self-explanatory. Press the dim button to enable the dim mode, which reduces the monitor output level by a preset amount. The dim button is always set to “latch” the function on and off. Dim activity applies no matter whether the monitor output level is being set by the rotary control or the reference button. The dim level can be configured for 10, 15, 20, or 25 dB, so one of those values will apply when dim is active. The LED associated with the dim button will light whenever dim is active. Note that if dim is enabled via the remote dim function, the dim LED will flash.

If the auto dim off function is enabled, whenever dim is on and the control room level is changed, dim will automatically return to the off state. Note that the auto dim off function is not active whenever dim is enabled due to the remote dim function being active. This allows remote control equipment, such as a talkback system, to reliably dim the monitor outputs.

Rotary Level Control

The rotary level control is used to manually adjust the monitor output level. It is active any time the reference level function is not active. When the rotary level control is set to give the same output level as the preset reference level, the reference LED will flash.

By default, when the rotary level control is set to its fully counterclockwise position, the monitor output channels automatically mute. This feature is provided for those users accustomed to having a completely quiet output when the level control is set to its minimum position.

A Model 69A configuration parameter allows the level control’s automatic mute all function to be disabled. When disabled, the rotary level control simply adjusts the monitor output level over its approximately 72 dB of range. When the control is in its fully counterclockwise position, low level audio signals will be present on the monitor outputs. This level control operating mode may be preferable for those users who do not like the abrupt level change when the automatic mute all function activates. When the automatic mute all function is disabled, the mute all button can be used to achieve a full monitor output mute.

Mute/Solo

The mute/solo mode button and the six monitor output channel buttons, along with associated LEDs, work together to provide excellent operating flexibility. The mute/solo mode switch allows the operator to select between mute and solo functions. Going from mute mode to solo mode, or vice-versa, clears all active mutes or solos. Pressing the mode switch twice is a legitimate means of quickly clearing muted or soloed channels.

In the mute mode, multiple channels can be muted simultaneously. A channel that is muted has its associated LED turned on. The solo mode can operate in one of two ways: additive or exclusive. How solo operates follows the configuration set in the Model 69A Control Console. In additive solo mode, multiple channels can be soloed simultaneously. A channel that is soloed has its associated LED flash on and off, while the LEDs on the non-soloed channels are not lit.

As expected, in the exclusive solo mode pressing a channel button will cause that channel to be soloed. But, in addition, any other channel or channels being soloed will go back to their normal, non-solo condition. Thus the exclusive solo mode allows rapid “soloing” of individual channels. Should more than one channel need to be simultaneously soloed, simply push and hold a channel button, then add the extra channels by momentarily pressing their buttons.

Remote Controls

Three remote control signals can be connected to the system and configured for the desired operating characteristics: mute all, dim, and input select. When remote mute all is activated the LED on the Model 69A associated with mute all will flash. If mute all was already active when the remote mute all function is activated, the LED will change from being steadily lit to flashing.

When Remote Dim is activated the LED on the Model 69A associated with the dim function will flash. If dim was already active when remote dim is activated, the LED will change from being steadily lit to flashing.

When remote input select is activated, the LED on the Model 69A associated with the selected input will flash. If the function is set for exclusive, no other LEDs will be lit. If the function is set for non-exclusive, the LED associated with remote input select will flash, while the LEDs associated with any other active inputs will remain steadily lit.

Technical Notes

Downmix

The downmix function is implemented in the Model 68 Central Control’s hardware using simple analog circuitry. From the factory downmix is defined as: center dropped in level by 6 dB and routed to left and right; left surround dropped in level by 3 dB and routed to left; right surround dropped in level by 3 dB and routed to right; LFE muted. By making simple resistor changes the level changes can be easily revised. In addition, provision has been made to allow the LFE signal to be routed to the left and right channels during downmix.

While no soldering is required, a competent technician is required to perform any changes to downmix function. This will help to ensure a safe and successful modification. Page 5 of the Model 68A schematic contains the circuitry that implements the downmix function. Please contact support@studio-tech.com for a copy of the schematic.

Bandpass Filter

The bandpass filter associated with the mono-to-center mode is created by cascading (connecting in series) a high-pass and a low-pass active filter. Each filter is a Sallen-Key type, with a 12 dB-per-octave response. The high-pass filter has a nominal -3 dB point at 100 Hz; the low-pass at 5 kHz. For a detailed description of the filters, refer to page 5 of the Model 68A schematic diagram. It is available upon request from support@studio-tech.com.

High-Pass Filter

Components were selected at the factory so that the high-pass filter section’s output

has a -3 dB point of nominally 100 Hz. (To be more precise, the math calculations work out to be 102 Hz.) For some applications it may be optimal to adjust this frequency. The Model 68A makes this a simple task, with no soldering or complicated procedure required.

The frequency of the high-pass filter is configured by means of three resistors, each identical in value. A 6-position socket, located on the Model 68A printed circuit board, is used to hold the resistors. As received from the factory, a 22 k ohm 6-pin single-inline-package (SIP) resistor is used to configure the filter for nominally 100 Hz. To revise the high-pass frequency this SIP resistor can be replaced. The SIP resistor must be an isolated-terminal-type, providing three independent resistors in one assembly. Alternately, using $\frac{1}{4}$ -watt 1%-tolerance resistors is appropriate.

A simple formula is used to determine the resistance required for a specific filter frequency: $R = 2,250,000 \div F$, where R is resistance in ohms and F is frequency in hertz.

It's important that any modifications be performed only by a competent technician.

Low-Pass Filter

Components were selected at the factory so that the low-pass filter section's output has a -3 dB point of nominally 5 kHz. (To be more precise, the math calculations work out to be 5.25 kHz.)

The frequency of the low-pass filter is configured by means of two $\frac{1}{4}$ -watt, 1%-tolerance resistors, each identical in value. One 6-pin socket, located on the printed circuit board, is used to hold the resistors. From the factory, two 14.3 k ohm resistors configure the filter for nominally 5 kHz.

One resistor is inserted into socket pins 1 and 2, the second into pins 3 and 4. To revise the frequency, these can be replaced with two other resistors, or one 6-pin SIP resistor package. It's important to note that the SIP resistor must be an isolated-terminal-type, providing three independent resistors in one assembly.

A simple formula is used to determine the resistance required for a specific filter frequency: $R = 75,000,000 \div F$, where R is resistance in ohms and F is frequency in hertz.

Monitor Output Gain Structure

The Model 68A Central Controller's monitor outputs are configured for unity gain. When the rotary level control on the Model 69A Control Console is set for maximum level (fully clockwise) the output level is essentially the same as the input level. The input trim potentiometers allow precise adjustment of the input circuitry. This was provided so that level variations in input sources, the Model 68A's circuitry, and the associated power amplifiers can be "trimmed out."

Definition of Level—dBu and dBV

Whenever possible, Studio Technologies has opted to use the dBu designation as it seems to be quite rational. Using dBm was fine when all audio line outputs were terminated with 600 ohm loads. In this way it was easy to say that 0 dBm is 1 milliwatt dissipated in the known load (i.e., 0 dBm across 600 ohms will measure 0.775 V). In contemporary situations an output is rarely terminated with 600 ohms; generally 10 k ohms or higher. The dBu designation

is better because it refers to dB referenced to 0.775 V, with no reference to load impedance. This takes into account today's audio scene where signals have a low source impedance, and a high input impedance. The dBu designation is becoming the standard for the professional audio industry.

The Model 68A is designed to interface with audio signals that have nominal signal levels of -12 dBV to +6 dBu. You might wonder why "dBV" came into the picture. Most people don't realize that equipment that utilizes "-10" levels usually mean -10 dBV—substantially different from -10 dBu (-10 dBV = -7.78 dBu). The dBV designation is simply a different way of measuring signal level and is often used when dealing with portable or consumer audio equipment. The dBV designation refers to dB referenced to 1.0 V, rather than dBu which refers to 0.775 V.

“Hot” Disconnection of the Model 69A Control Console

Should you need to relocate the Model 69A while your StudioComm system is operating, there is no reason why you can't disconnect the cable, move the unit, and then connect it again. If the Model 69A is disconnected while it is operating, the current operating parameters are saved in nonvolatile memory and the Model 68A Central Controller will continue to operate as before the connection was broken. No clicks, pops, or other noises will occur when the Model 69A is again connected. The Model 69A will go through its standard power-up sequence, send a message to reset power-up defaults, then send the operating parameters as stored in its memory.

Monitor Output Transient Protection

The Model 68A Central Controller contains a power up/power down transient protection feature. This limits the chance of damage to the monitor loudspeakers during the time when AC mains voltage is connected, disconnected, or has changed significantly from nominal. A combination of hardware and software is used to monitor one of the power supply “rails.” Until the AC mains input exceeds approximately 69% of its nominal voltage, electromechanical relays maintain a short circuit condition on the monitor outputs. After a short delay the relays are allowed to function normally. Whenever the AC mains input drops below approximately 67% of its nominal voltage, the relays immediately go to their mute state. During testing it was found that upon power up the monitor outputs remained very quiet; during power down a moderate “tick” was the worst that was heard.

Mono-to-Center Polarity

It's worthwhile to note that a polarity inversion takes place whenever the mono-to-center function is active. By design, the input signals experience a 180-degree inversion in the Model 68A's mono-to-center combining circuitry. This should not cause a problem as monitoring audio signals over a single loudspeaker is considered polarity insensitive. Only during electrical testing would this condition be detected.

Model 68A to Model 69A Connections

Figure 8 gives a detailed view of the signals that connect between the Model 68A Central Controller and the Model 69A Control Console. The Model 68A provides

+15 Vdc power for the Model 69A. The Model 69A generates MIDI system-exclusive messages and sends them to the Model 68A. From the outside world, the remote control input sources connect to the Model 68A. They then route, via the interface cable, from the Model 68A to the actual input circuitry, located in the Model 69A.

Pin	Signal	Direction
1	Power Supply Common	68A to/from 69A
2	+15 Vdc	68A to 69A
3	Data (MIDI System-Exclusive)	69A to 68A
4	Data Common	69A to/from 68A
5	Remote Mute All	68A to 69A (Note 2)
6	Remote Dim	68A to 69A (Note 2)
7	Spare Remote Input	68A to 69A (Note 2)
8	Remote Input Select	68A to 69A (Note 2)
9	Remote Control Common	68A to/from 69A

Notes: 1) Connector types on Model 68A and Model 69A are 9-pin D-subminiature female. Connectors use 4-40 threaded inserts for locking with mating plug.
2) Remote control sources connect to D-sub on Model 68A, then passively route to Model 69A via 68A/69A interface D-sub.

Figure 8. Connections between Model 68A and Model 69A

Specifications

Model 68A Central Controller

General Audio:

Frequency Response: 20 Hz-20 kHz ± 0.1 dB (down 0.5 dB @ 60 kHz), monitor outputs

Distortion (THD+N): 0.03%, measured at 1 kHz, +4 dBu, monitor outputs

S/N Ratio: 92 dB, ref +4 dBu out

Crosstalk: 78 dB, ref +4 dBu in

Audio Line Inputs: 16, organized as two 6-channel inputs and two 2-channel inputs

Type: electronically balanced, direct coupled

Impedance: 24 k ohms

Nominal Level: -12 dBV to +6 dBu

Input Level Control: 15-turn trim potentiometers allow calibration over -12 dBV to +6 dBu input range

Maximum Input Level: +27 dBu

Common Mode Rejection: 90 dB @ DC and 60 Hz, 85 dB @ 20 kHz, 60 dB @ 400 kHz (typical)

Monitor Outputs: 6-channel surround, 2-channel stereo

Type: electronically balanced, intended to drive balanced or unbalanced loads of 600 ohms or greater

Nominal Level: unity gain, audio inputs to monitor outputs

Maximum Output Level—Balanced: +27 dBu into 10 k ohms, +26 dBu into 600 ohms

Maximum Output Level—Unbalanced: +21 dBu into 10 k ohms, +20 dBu into 600 ohms

Output Impedance—Balanced: 50 ohms

Level Control Method: laser-trimmed voltage-controlled-amplifier integrated circuits manufactured by THAT Corporation

Attenuation Range: 72 dB, nominal, using rotary level control

Bandpass Filter:

Type: created by cascading (connecting in series) a high-pass and low-pass filter; each filter 2nd-order (12 dB-per-octave) Sallen-Key

Response: -3 dB @ 100 Hz and 5 kHz, nominal

Connectors:

Audio: 3, 25-pin D-subminiature female

Control: 2, 9-pin D-subminiature female

AC Mains: 3-blade IEC-type

Remote Control Inputs: 4, HCMOS-type logic, "pulled up" to +5 Vdc using 10 k ohm resistors, activates on closure to system common

AC Mains Requirement:

100, 120, or 220/240 V, $\pm 10\%$, factory configured, 50/60 Hz, 100-120 V 0.4 A maximum, 220/240 V 0.2 A maximum

Dimensions (Overall):

19.00 inches wide (48.3 cm)

1.72 inches high (4.4 cm)

8.75 inches deep (22.2 cm)

Mounting:

One space in a standard 19-inch-type rack

Weight: 8.2 pounds (3.7 kg)

Model 69A Control Console

Application: operates in conjunction with Model 68A Central Controller

Power: provided by Model 68A Central Controller

Output Data: generates MIDI system-exclusive messages

Connector: 1, 9-pin D-subminiature female

Dimensions (Overall):

7.2 inches wide (18.3 cm)

2.2 inches high (5.6 cm)

5.4 inches deep (13.7 cm)

Weight: 1.9 pounds (0.9 kg)

Specifications subject to change without notice.

Appendix A

Controlling the Model 68A

The Model 68A Central Controller uses MIDI system-exclusive messages to control all functions. The Model 69A Control Console is programmed to generate a subset of what the Model 68A is capable of doing. By using standard MIDI messages, the Model 68A can be used for a wide range of special applications. Any device that can be programmed to send system-exclusive MIDI messages can be used to control the Model 68A.

General Notes:

All MIDI messages to be acted upon are system-exclusive type (F0H). No channel mode, system common, or system real time messages are utilized.

Studio Technologies, Inc. manufacturer's ID number is 00H 00H 56H.

The Model 68A's product device ID number is 05H.

Function: Reset to Power Up Default Configuration

Byte	Value	Description
1	F0H	System-Exclusive Message
2	00H	1 st Byte of Studio Tech ID
3	00H	2 nd Byte of Studio Tech ID
4	56H	3 rd Byte of Studio Tech ID
5	05H	Product ID (Model 68A)
6	00H	Function, Restore Power Up Default Configuration
7	F7H	EOX, End of System-Exclusive Message

Notes: Action taken after message is received:
Set all input sources to off.
Set all monitor output channels to off.
Set monitor output level to minimum.
Set mono function to off.
Set downmix function to off.

Function: Input Source and Associated Channels

Byte	Value	Description
1	F0H	System-Exclusive Message
2	00H	1 st Byte of Studio Tech ID
3	00H	2 nd Byte of Studio Tech ID
4	56H	3 rd Byte of Studio Tech ID
5	05H	Product ID (Model 68A)
6	01H	Function, Input Source and Associated Channels
7	0nH	Input Source, range 1-4: 1=Surround A 2=Surround B 3=Stereo A 4=Stereo B
8	nnH	Input Channel Status Bit Map (sum values from all six channels): Channel 1 (L): off=00; on=01 Channel 2 (C): off=00; on=02 Channel 3 (R): off=00; on=04 Channel 4 (LS): off=00; on=08 Channel 5 (RS): off=00; on=10 Channel 6 (LFE): off=00; on=20
9	F7H	EOX, End of System-Exclusive Message

Note: Inputs 3 and 4 only have input channels 1 (L) and 3 (R) associated with them. Channels 2 (C), 4 (LS), 5 (RS), and 6 (LFE) are not physically present on inputs 3 and 4.

Function: Monitor Output Channel Status

Byte	Value	Description
1	F0H	System-Exclusive Message
2	00H	1 st Byte of Studio Tech ID
3	00H	2 nd Byte of Studio Tech ID
4	56H	3 rd Byte of Studio Tech ID
5	05H	Product ID (Model 68A)
6	02H	Function, Monitor Output Channel Status
7	nnH	Surround Monitor Output Channel Status using Monitor Output Relays Bit Map (sum values from all six channels): Channel 1 (Surround L): off=00; on=01 Channel 2 (Surround C): off=00; on=02 Channel 3 (Surround R): off=00; on=04 Channel 4 (Surround LS): off=00; on=08 Channel 5 (Surround RS): off=00; on=10 Channel 6 (Surround LFE): off=00; on=20
8	nnH	Surround Monitor Output Channel Status using Input Analog Switches Bit Map (sum values from all six channels): Channel 1 (L): normal=00; mute=01 Channel 2 (C): normal=00; mute=02 Channel 3 (R): normal=00; mute=04 Channel 4 (LS): normal=00; mute=08 Channel 5 (RS): normal=00; mute=10 Channel 6 (LFE): normal=00; mute=20
9	0nH	Stereo Monitor Output Channel Status using Monitor Output Relays Bit Map (sum values from both channels): Channel 1 (Stereo L): off=0; on=1 Channel 2 (Stereo R): off=0; on=2
10	F7H	EOX, End of System-Exclusive Message

Function: Monitor Output Level - Normal

Byte	Value	Description
1	F0H	System-Exclusive Message
2	00H	1 st Byte of Studio Tech ID
3	00H	2 nd Byte of Studio Tech ID
4	56H	3 rd Byte of Studio Tech ID
5	05H	Product ID (Model 68A)
6	03H	Function, Monitor Output Level - Normal
7	nnH	Monitor Output Level, MSB, range 00-7F
8	0nH	Monitor Output Level, LSB, range 0-1
9	F7H	EOX, End of System-Exclusive Message

Notes: Control console sends new value each time monitor output level is changed.

Monitor output level is 8-bit precision, spread over two MIDI bytes: 00H 00H lowest; 7FH 01H highest. MIDI byte 7 is monitor output level bits 2-8; MIDI byte 8 is monitor output level bit 1.

Dim function is performed by control console and is sent using monitor output level command.

Function: Monitor Output Level - Reverse

Byte	Value	Description
1	F0H	System-Exclusive Message
2	00H	1 st Byte of Studio Tech ID
3	00H	2 nd Byte of Studio Tech ID
4	56H	3 rd Byte of Studio Tech ID
5	05H	Product ID (Model 68A)
6	04H	Function, Monitor Output Level - Reverse
7	nnH	Monitor Output Level, MSB, range 00-7F
8	0nH	Monitor Output Level, LSB, range 0-1
9	F7H	EOX, End of System-Exclusive Message

Notes: Not sent by control console. Provided for special applications.

Monitor output level is 8-bit precision, spread over two MIDI bytes: 00H 00H highest; 7FH 01H lowest. MIDI byte 7 is monitor output level bits 2-8; MIDI byte 8 is monitor output level bit 1.

Dim function is performed by control console and is sent using monitor output level command.

Function: Mono

Byte	Value	Description
1	F0H	System-Exclusive Message
2	00H	1 st Byte of Studio Tech ID
3	00H	2 nd Byte of Studio Tech ID
4	56H	3 rd Byte of Studio Tech ID
5	05H	Product ID (Model 68A)
6	05H	Function, Mono
7	0nH	Mono Status, range 0-3: 0=off 1=on, L+R sent to left and right channels of monitor output 2=on, L+R sent to center channel of surround monitor output 3=on, Bandpassed L+R sent to center channel of surround monitor output
8	F7H	EOX, End of System-Exclusive Message

Function: Downmix

Byte	Value	Description
1	F0H	System-Exclusive Message
2	00H	1 st Byte of Studio Tech ID
3	00H	2 nd Byte of Studio Tech ID
4	56H	3 rd Byte of Studio Tech ID
5	05H	Product ID (Model 68A)
6	06H	Function, Downmix
7	0nH	Downmix Status, range 0-1: 0=off 1=on
8	F7H	EOX, End of System-Exclusive Message

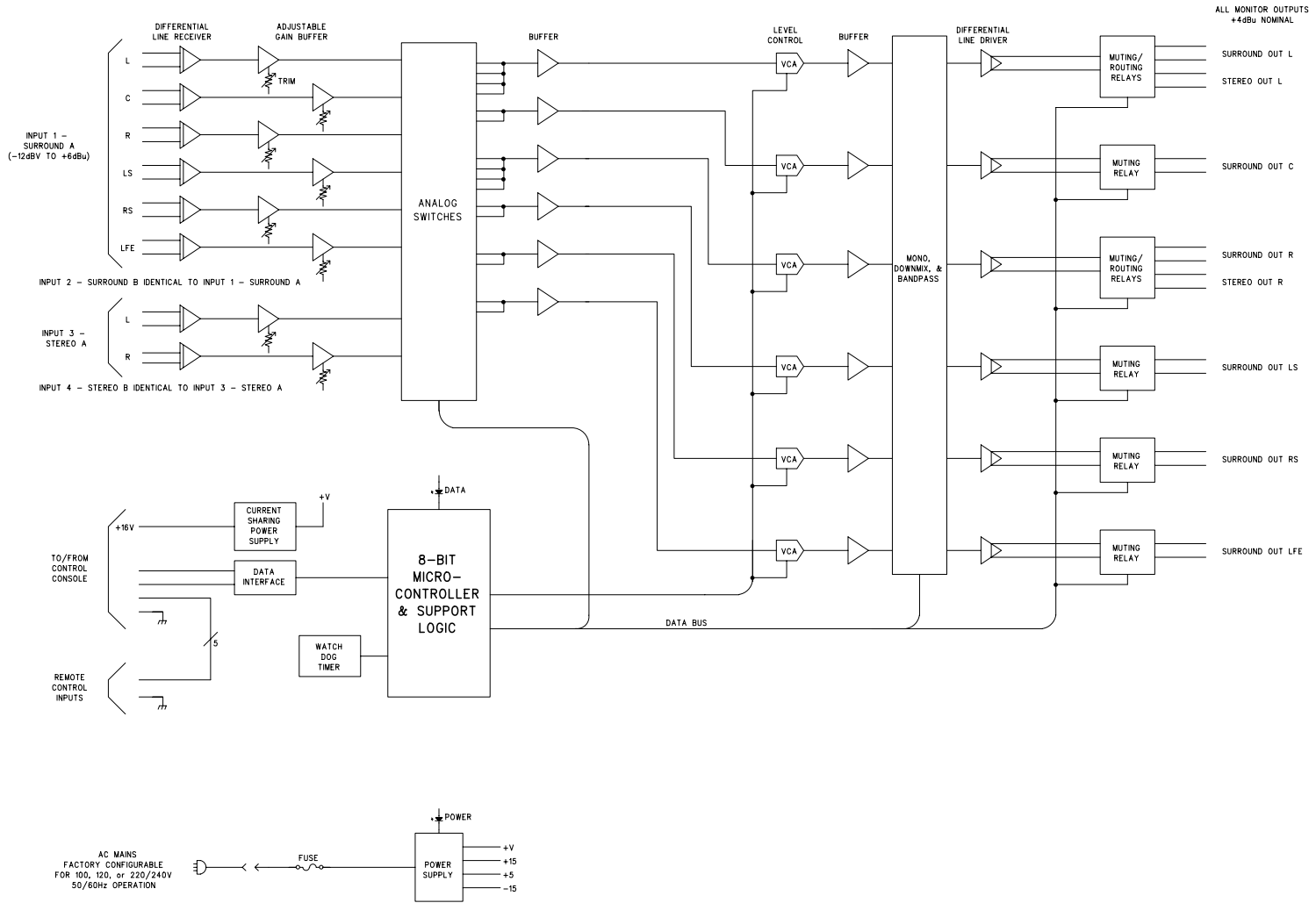

M68ABD_A

STUDIO TECHNOLOGIES, INC.

MODEL 68A
CENTRAL CONTROLLER
BLOCK DIAGRAM

DRAWING NO.	DATE	PAGE
30948	01/24/01	01 of 01

THIS BLOCK DIAGRAM APPLICABLE FOR SN 00501 AND LATER

TO/FROM
MODEL 68A
CENTRAL
CONTROLLER

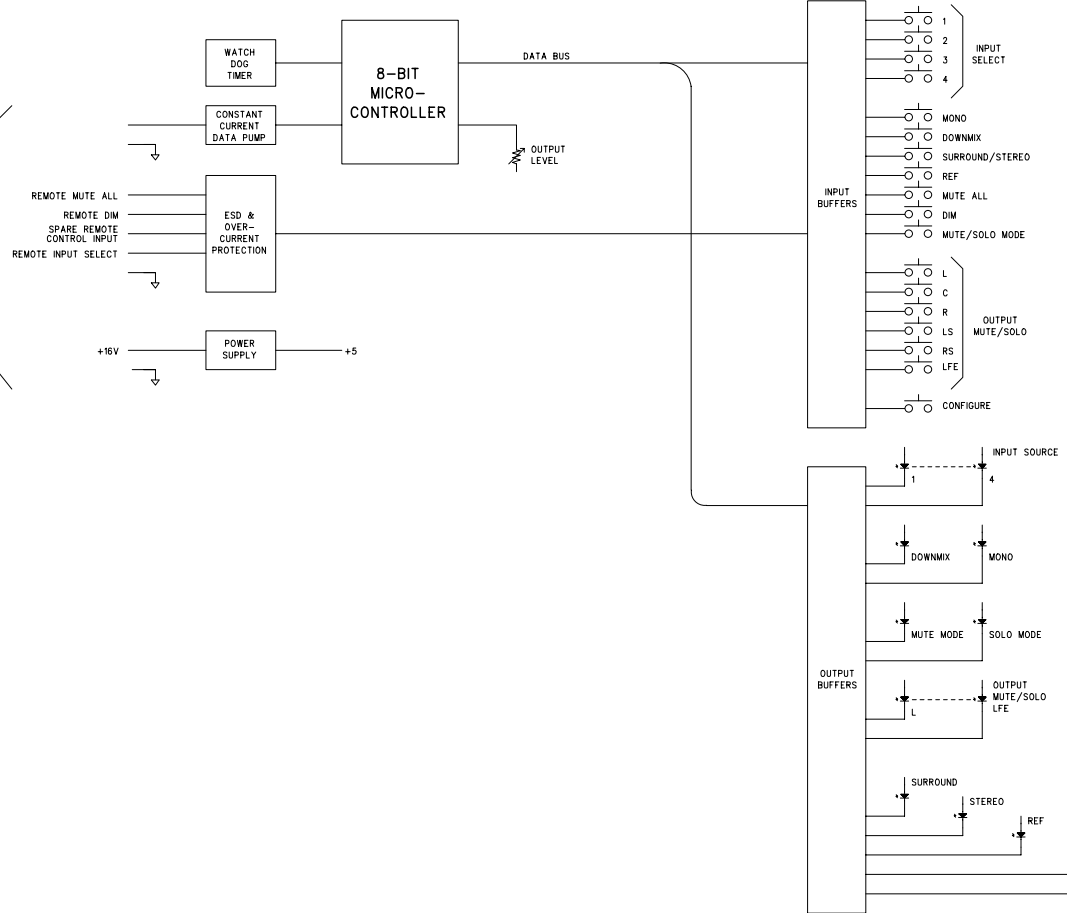

M69ABD_A

STUDIO TECHNOLOGIES, INC.		
MODEL 69A CONTROL CONSOLE BLOCK DIAGRAM		
DRAWING NO. 30949	DATE 12/20/00	PAGE 01 of 01

THIS BLOCK DIAGRAM APPLICABLE FOR SN 00501 AND LATER

