

Model 233

Announcer's Console

User Guide

Issue 3, December 2008

This User Guide is applicable for serial numbers:
M233-00170 and later
and units upgraded with software version 1.01 and higher

Copyright © 2008 by Studio Technologies, Inc., all rights reserved

www.studio-tech.com

This page intentionally not left blank.

Table of Contents

Introduction	5
System Features	6
Installation and Setup	12
Configuration	17
Operation	29
Advanced Operation	34
Technical Notes.....	35
Specifications.....	44
Appendix A.....	45
Block Diagram	

This page intentionally not left blank.

Introduction

What This User Guide Covers

This User Guide is designed to assist you when installing, configuring, and using the Model 233 Announcer's Console. Additional background technical information is also provided. A product block diagram is included at the end of this guide.

System Overview

The Model 233 Announcer's Console is designed to serve as the audio control "hub" for announcers, commentators, and production personnel. The tabletop unit is suited for numerous applications including on-air television and radio broadcasting. The Model 233 will also perform an outstanding role in stadium announce applications. The Model 233 is compatible with essentially all broadcast and production audio system environments. Standard connectors are used to interface microphone, headphone, on-air, talkback, line input, and intercom signals.

Whether it's the mic preamplifier, audio switching, talkback signals, intercom interfacing, or headphone cue feed, superior audio quality is maintained throughout. A microprocessor provides the Model 233's logic power, allowing precise control of the unit's operation. With extensive flexibility built in, creating the desired operating configuration is a simple matter. While the operating features of the unit can be carefully tailored, the user is presented with an easy-to-use set of controls and indicators. A wide range of resources, great performance, and simplicity during use—these are the hallmarks of the Model 233.

The Model 233 is a truly "next-generation and then some" product. Exhaustive research into the needs and desires of field production personnel was integral to its creation. Providing a veritable "tool kit" of features, the unit supports a wide variety of applications that include on-air television and radio broadcasting, stadium announcement, and simultaneous interpretation. In addition, with the unit's broad range



Figure 1. Model 233 front panel

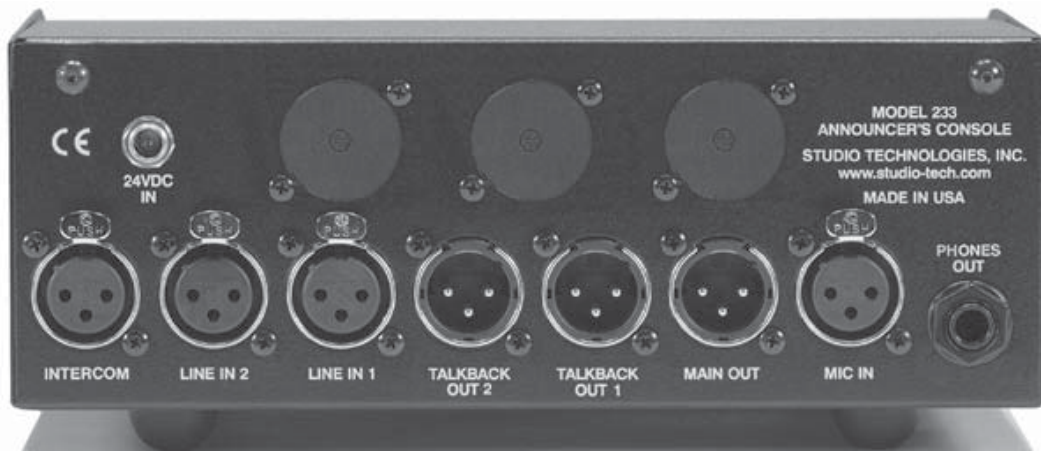

Figure 2. Model 233 back panel

of capabilities many other specialized “behind-the-scenes” applications can also be implemented.

System Features

Microphone Input

A high-performance microphone preamplifier circuit provides low-noise/low-distortion amplification over a 20 to 60 dB gain range. The gain is adjustable in 10 dB steps. The input is compatible with balanced dynamic and condenser microphones. The microphone power source is 48 volts nominal and meets the worldwide P48 phantom power standard. An LED indicator serves as an aid for optimizing the preamplifier’s gain setting. The output of the microphone preamplifier is used by the main output as well as being routed to the compressor circuit that supports the talkback functions.

Main Output

The Model 233 provides a main output that is designed to serve as the on-air, stadium announcement, or other primary audio feed. Nominally -2 dBu, it is designed as a fully professional interface with high output capability, low distortion, and low noise.

The output circuitry features a high-performance output transformer expressly designed for professional audio applications.

Talkback Functions

The talkback functions are intended to provide personnel associated with production trucks, control rooms, live-performance, and sports venues with talent-originated cue signals. The Model 233 contains two pushbutton switches that control the talkback functions. Associated with each pushbutton switch is a dedicated line-level talkback output. Each pushbutton switch can also be configured to send audio to one specific channel associated with the Model 233’s dual-channel intercom interface.

The line-level talkback outputs are transformer-coupled with a $+4$ dBu nominal signal level. They contain resistors in series with the output connectors, allowing line-level talkback outputs from multiple units to be directly “summed.”

For non-on-air applications, a special Model 233 feature set can be enabled by placing the unit in its “production” mode. This software-based mode allows the

main output to be used as an additional talkback output. This feature makes the unit even more powerful when used in live-event applications, such as serving as a master console for an orchestra conductor or production director.

With all the available talkback flexibility, the exact needs of many specific applications can easily be met. And, of course, whatever configuration is implemented, the audio quality will be excellent.

Dynamic Range Control

To enhance the Model 233's talkback functions, a studio-quality compressor circuit is provided to control the dynamic range of the signal coming from the microphone preamplifier. Far from a simple "clipper," the circuit utilizes a sophisticated laser-trimmed voltage-controlled-amplifier (VCA) integrated circuit for quiet, low-distortion level control.

The signal from the compressor is always used by the talkback functions. For flexibility, the audio source for the main output can be selected to be either the direct output of the microphone preamplifier or the output of the compressor. For on-air applications the signal coming directly from the microphone preamp would be correct. But having dynamic range control of the signal going to the main output can offer increased performance for selected applications. These could include stadium announcement locations, award show conductor positions, and use with non-professional announcers during sports events.

User Controls and Status Indicators

Three pushbutton switches, four LED indicators, and three rotary controls

provide users with a clear, easy-to-use interface. One pushbutton switch controls the status of the main output. This is the audio output intended for on-air, stadium announcement, or other primary uses. Two LEDs display the on/off status of the main output. Two additional pushbutton switches control the status of the talkback functions. These are the audio cue signals used to communicate with producers, directors, "spotters," or other behind-the-scenes production personnel. A status LED is associated with each talkback button. Three rotary controls allow the user to adjust the level of the headphone output. Two of the controls are associated with externally connected cue signals. The third control is associated with the Model 233's sidetone function, allowing the user to monitor the signal associated with the unit's microphone input.

Flexibility

A large part of the Model 233's unique power is the ability to configure the operation of the main output and talkback functions. To meet the needs of the many specific broadcast and production applications, a variety of button operating modes is available. The main output button can be selected to operate from among four modes. In the "push-to-mute" mode the button performs a momentary mute of the main output. In this way a "cough" button function is created, something typically required for television sports broadcasting. In the "push-to-talk" mode the button provides a momentary active function for the main output. This mode would be appropriate for applications such as stadium announcement. An alternate action "latching" configuration allows the button to enable or disable the main output as desired. This is useful in

radio broadcasting, announce-booth, or voice-over applications. The fourth mode provides a hybrid function, supporting both push-to-talk and tap-to-enable/tap-to-disable operation. This operation is similar to that found in many broadcast intercom system user stations.

The two buttons associated with the talk-back functions can be configured to operate from either of two modes. One of the modes supports a “push-to-talk” function. This is typically used for on-air broadcast applications. The other mode provides a hybrid function, the operation of which is discussed in the previous paragraph. The hybrid mode is especially useful when the Model 233 is used in a production-support application.

The main button mode configures how the main output, when it is in the “latched” on state, responds to talkback activity. One choice momentarily turns off the main output when talkback is active, returning the main output to the on state when the talkback function has ended. The other choice “unlatches” the main output in response to a talkback function.

Cue Sources

The Model 233 supports the connection of up to four external audio sources, each of which can be selected for routing to the stereo headphone output. The sources are line input 1, line input 2, intercom channel 1, and intercom channel 2. Each source can be individually assigned to the left channel, the right channel, or both the left and right channels. This allows a wide variety of stereo and mono headphone mixes to be created.

For application flexibility, two line-level audio sources can be connected to the Model 233. Possible signal sources

include off-air receivers, wireless IFB systems, and audio consoles. The connected signals can be from two independent sources, or could be from a stereo audio feed such as would be associated with a broadcast music event. Two level trim potentiometers, located on the bottom of the unit, allow signals with wide nominal audio levels to be cleanly interfaced.

Audio signals associated with a single- or dual-channel intercom system can be routed to the headphone output. The Model 233's intercom interface is compatible with standard party-line intercom systems from manufacturers such as RTS™ and Clear-Com®. A broadcast-type IFB (interrupted foldback) circuit can also be connected to the intercom input. This “listen only” signal is often found in television broadcast applications.

Sidetone

The Model 233 includes an integrated sidetone function that allows the output of the compressor circuit associated with the microphone preamplifier to be routed to the stereo headphone output. This provides a confidence signal to the user, allowing them to hear exactly what is being sent to the main and, if desired, talkback outputs. This sidetone signal can be a critical element when creating an effective communications environment.

In on-air television and radio broadcast settings the Model 233 user's own microphone audio signal is typically returned to the headphone output by way of a cue audio source. But there are cases where this signal is not available, such as when “mix minus” cue feeds are utilized. This type of cue feed includes everything but the user audio, a requirement when significant time delays, typically associated

with satellite transmission systems, are present. In effect the Model 233's sidetone function adds the "minus" part to a "mix minus" cue.

Several configurable parameters allow the sidetone function to be tailored to the needs of a specific Model 233 installation. The sidetone function can be configured to route audio to the left, right, or left and right headphone outputs. It can also be completely disabled. Sidetone can also be configured to be active only when the main output is active, or to be active anytime the main output or either of the talkback outputs is active.

Headphone Output

Three rotary controls are provided for user adjustment of the headphone output. Two of the controls adjust the levels of the externally connected sources. The third control is used to set the level of the sidetone function.

For flexibility the actual functioning of the two controls associated with the external sources is configurable. For traditional on-air sports applications they can be selected to the dual level control mode which provides independent control of the left and right channel volume. For use with stereo cue signals, or to support user preference, the level/balance mode can be selected. In this mode one control adjusts the overall level of both the left and right channels, while the other allows adjustment of the left/right level balance. To help minimize the chance of broadcast cues being missed, both level control modes can be configured so that a minimum headphone output level is maintained. Alternately, the headphone output can be set to fully mute when these controls are at their minimum position.

A headphone control reverse mode is provided specifically for on-air television applications where a headset with boom microphone is used. The reverse mode ensures that no matter which headset orientation is used by the talent, the two "pots" controlling the external sources will always work intuitively. This will result in a comfortable work environment, allowing the "left" control to impact the level to the talent's left ear while the "right" control impacts the right.

The sidetone level control is dedicated to adjusting the level of the mic audio signal that's routed to the headphone outputs. Configuration switches allow which of the headphone outputs—left, right, or both—will receive the sidetone signal. When the sidetone level control is set to its minimum position the sidetone level is always set to be fully muted.

Provision has been made to support applications where a monaural cue feed is desired. A configuration switch allows the summing (combining) of the selected left and right headphone sources. In addition to creating a dual-channel mono output it also allows the level controls to be configured as a simple 3-channel mixer.

The headphone output is optimized to meet the needs of contemporary headphones and headsets. Specifically, the output circuits act as voltage, rather than power, drivers. In this configuration they can provide high output levels with very low distortion and noise, along with minimal current consumption. The output circuits are configured to safely drive stereo or mono loads. This ensures that all types of headphones, headsets, and earpieces can be directly connected.

Intercom Interface

Of special note is the Model 233's sophisticated intercom interface. It's designed to work correctly with industry-standard single- and dual-channel party-line intercom systems, including those from RTS and Clear-Com. An intercom line connected to the Model 233 can serve three functions: providing cue audio signals to the headphone output, allowing talkback audio to be sent to intercom users, and acting as a Model 233 power source. Audio signals present on the single- or dual-channel intercom line can be flexibly routed to the stereo headphone output. Talkback audio, controlled by the two talkback pushbutton switches, can be sent to either or both of the intercom channels. Trim potentiometers, located on the bottom of the unit, allow adjustment of the talkback-to-intercom sidetone (null) level.

Other announcer console products can exhibit talkback-to-intercom-related audio oscillations ("squeals") that end up in the headphone output. A unique Model 233 feature ensures that this will never occur. This is accomplished by means of a special "auto-terminate" circuit that becomes active whenever an intercom line is not connected to the Model 233.

Audio Quality and Protection

The Model 233's circuitry is carefully tailored to provide excellent audio performance. Professional-quality components are featured throughout. For reliability all audio routing is performed using solid-state devices under microcontroller direction. In all critical audio paths, "clickless" electronic switches provide noise-free control. All audio inputs and outputs make extensive use of protection components. This limits the chance of damage from ESD and other undesirable, yet real-world, hazards.

Power Sources

The Model 233 can derive its operating power from an intercom line or an external 24 volt DC source. For redundancy, both power sources can be connected simultaneously. An internal switch-mode power supply ensures that all Model 233 features are available, including phantom power, when the unit is powered by either source.

Auxiliary Relay

Model 233 resources include a general-purpose relay, allowing specialized configurations to be created. Under software control, the relay can be configured to follow the state of the main output, talkback 1, or talkback 2 buttons. Taking advantage of the back-panel locations provided for additional XLR-type connectors, a technician may easily create functions such as an "on-air" indicator or implement a loudspeaker muting during talkback function. Special configuration modes are even included to allow direct control of the relay using the talkback 1 or talkback 2 buttons without impacting any of the Model 233's audio signals.

Tally Output

Another unique Model 233 feature is the tally output. It provides an indication, in the form of a current-limited DC signal, of the status of the main output. Whenever the main output is active the tally output is active. This 3.5 volt nominal, 12 milliamperes maximum, signal is capable of directly lighting an LED indicator or triggering an external control system. The tally output is provided specifically for specialized applications such as television award show broadcasts where remote monitoring and control of the main output is required.

Configuration

Model 233 configurations are made using a number of DIP-type switches and four trim potentiometers. One 8-position switch array is used to set the gain of the microphone preamplifier, the on/off status of phantom power, and control of the headphone output mode. A 12-position switch array configures which of the four cue audio sources, as well as the sidetone audio, are routed to the headphone outputs. In addition, the last two sections of the 12-position switch array are used to select whether talkback audio will be routed to the intercom interface. Two 8-position switch arrays communicate the desired operating modes to the microprocessor.

Two rotary “trim pots” are used to adjust the sensitivity of the line inputs. Two additional rotary trim pots are provided to adjust the sidetone (null) level for the intercom interface’s talkback functions.

All switches and trim pots are accessible via the bottom of the Model 233’s enclosure; the unit does not have to be disassembled. Changes made to any of the configuration parameters become active immediately. To prevent access to the configuration controls a security panel, included with each unit, is attached to the bottom of the enclosure.

Connectors

The Model 233 uses standard connectors throughout. The microphone input, line inputs, and intercom interface functions use 3-pin female XLR-type connectors. The main and line-level talkback output functions use 3-pin male XLR connectors. The headphone output utilizes a ¼-inch 3-conductor jack. The external source of 24 volt DC power is connected by way of a 2.1 x 5.5 mm “locking” coaxial power jack.

Additional Connector Locations

In the world of broadcast, production, and public address audio it’s fair to say that applications vary widely. To this end, up to three additional XLR-type connectors can be easily mounted into the Model 233’s back panel. Multiple 3-position “headers” located on the Model 233’s circuit board provide technician-access to literally every input and output connection. In addition, some additional features, including the remote control inputs and tally output, are accessible using 3-position headers. Using a factory-available interface cable kit, these headers allow a Model 233 to be optimized to meet the exact needs of specific applications. For example, some applications may prefer to use a multi-pin XLR-type connector to interface with a headset. This could be easily accomplished by adding the appropriate 6- or 7-pin XLR-type connector and making a few simple connections. Other applications may benefit from having “mult” or “loop-through” connections, something easily incorporated into a Model 233.

Multi-Pin Headset Connectors

As previously mentioned, some applications are best supported using headsets that interface using a multi-pin connector. In most of these cases the desired connectors are 6- or 7-pin male XLR-type wired to an industry-standard pin-out scheme. Studio Technologies offers headset connector assemblies that allow fast and painless installation into a spare connector location in the Model 233’s back panel. Details about these optional assemblies are available on the Studio Technologies website.

Options

The Model 233's standard resources are more than sufficient to directly support a large number of applications. But in the "real world" of audio and intercommunications special needs always seem to arise. To that end, Studio Technologies offers a number of option cards. In addition to passive or active components, each card contains an integral connector, allowing simple installation into a spare connector location on the Model 233's back panel. For interest, the resources provided by some of these option cards are worth describing.

- The direct microphone output card provides access to the dynamic or condenser microphone that is connected to the Model 233's mic input. Passive components, along with the auxiliary relay contact, create a "click-free" microphone-level audio signal.
- The remote switch input card uses a 4-pin XLR connector to provide access to the Model 233's remote switch inputs.

Other general-purpose option cards provide 3-pin XLR, 4-pin XLR, and 8-pin EtherCon® connectors. With the range of option cards available it's hard to imagine an application that can't be served. But you're welcome to try to "stump the chumps" in the Studio Technologies technical support department! But first please check the complete list of the available option cards listed on the Studio Technologies website.

Installation and Setup

In this section interconnections will be made using the input and output connectors located on the Model 233's back panel. Microphone, line-level audio sources, intercom, main output, and line-level talk-back output signals are interfaced by way of 3-pin XLR-type connectors. A ¼-inch 3-conductor phone jack is provided for the headphone output. A 2.1 x 5.5 mm coaxial jack allows connection of an external 24 volt DC power source.

System Components

The following is included in the shipping carton: Model 233 Announcer's Console, user guide, button label sheet, and 24 volt DC power supply. For units shipped to destinations in Japan and North America the power supply will have a nominal AC mains input of 120 volts. For all other destinations a power supply compatible with 220/240 volt AC mains will be included.

Microphone Input

The Model 233 is compatible with balanced dynamic and condenser microphones. Depending on the application, the microphone may be part of a headset, or be an independent handheld or stand-mounted model. The Model 233's nominal 48 volt power source will support essentially all phantom-powered microphones. The quality of the Model 233's microphone preamplifier and associated circuitry is such that special applications may benefit from using "high-end" microphones. If selected appropriately, models from manufacturers such as AKG, Beyerdynamic, Crown, Neumann, Sennheiser, and Shure will perform very well in Model 233 applications.

The selected microphone is interconnected by way of a 3-pin female XLR-type connector which is located on the Model 233's back panel. The mating connector (male) should be wired so that pin 2 is signal high (+ or hot), pin 3 is signal low (– or cold), and pin 1 is shield. It's possible that an unbalanced microphone will also work correctly but is not recommended. However, if this is necessary the mating connector (male) should be wired so that pin 2 is signal high (+ or hot), and signal common/shield is connected to both pins 1 and 3.

The Model 233 is not compatible with unbalanced “electret”-type microphones that require a source of low-voltage DC for operation. These microphones, sometimes found in low-cost headsets, are not generally suitable for on-air or other demanding applications.

As of the writing date of this user guide, the Sennheiser HMD25 headset remains popular for on-air broadcast use. A fine product, it works very well with the Model 233. Note that adding the suffix “-XQ” to the headset's part number (HMD25-XQ) specifies a 3-pin male XLR-type connector for the dynamic microphone and a ¼-inch 3-conductor plug for the stereo headphones. This configuration is very useful, allowing the headset to work directly “out of the box” with the Model 233.

If the writer may digress for a moment to recount a story... an audio dealer once shared a secret with me concerning headsets. He loved selling the “lower-end” (less expensive) headset models, which he did by the veritable “boatload.” Why? Because these usually broke soon after going into service! He knew that on a regular basis he'd receive orders for more of them. Had these users, from the beginning,

purchased only premium-quality headsets, their total cost of ownership would have been much less. Enough said...

Headphone Output

The Model 233's headphone output is compatible with stereo or mono headphones, headsets, or earpieces. Connecting devices with a nominal impedance of 100 ohms or greater is preferred. This shouldn't be an issue as essentially all contemporary devices already meet this condition.

Devices are connected to the headphone output by way of a ¼-inch 3-conductor phone jack located on the Model 233's back panel. As is standard for stereo headphones, the left channel is connected to the “tip” lead of the ¼-inch headphone jack. The right channel is connected to the “ring” lead of the jack. Common for both channels is connected to the “sleeve” lead.

Devices with ¼-inch 2-conductor “mono” plugs can also be used with the Model 233's headphone output. In this arrangement only the tip lead (left channel) will be active. The 2-conductor plug will physically connect (“short”) the ring lead (right channel) to the sleeve lead (common). Technically this won't damage the circuitry associated with the right-channel headphone output. (51 ohm protection resistors are electrically in series with the headphone output circuits.) However, energy will be wasted if an audio signal coming out of the right channel goes into a “dead” short. There is a simple means of eliminating this issue; when configuring the headphone sources simply do not assign any to the right channel headphone output. Refer to the Configuration section of this user guide for details.

Main Output

The Model 233's main output is intended to be the "on-air" or primary signal that typically connects to the input of an audio console. The output is transformer balanced with a nominal signal level of -2 dBu. The actual level will depend upon the gain setting of the microphone preamplifier, sensitivity of the microphone, and how loudly the user speaks into the microphone. The transformer used in the main output is intended for professional audio applications. Its source impedance is very low and can drive lengthy cable runs without difficulty. It is capable of driving loads as low as 600 ohms but performs best with loads of 2 k ohms or greater. (This should not prove to be an issue as virtually all contemporary audio equipment has a relatively high input impedance.) As the secondary winding of the output transformer connects directly to the main output connector, care should be taken so that a DC voltage is never present on the interconnecting cable.

The main output is interfaced by means of a 3-pin male XLR-type connector located on the Model 233's back panel. The interconnecting cable's mating connector (female) should be wired so that signal high (+ or hot) is on pin 2 and signal low (– or cold) is on pin 3. The cable's shield can be connected to pin 1, but it will have no function. Also, the cable's shield must not be terminated on the metal "shell" connection of the mating connector. To limit the chance of grounding interaction between the Model 233 and connected equipment, pin 1 on the main output's connector is isolated from any point in the Model 233. The fact that pin 1 "floats" will minimize the chance of hums, noises, or buzzes being present on the equipment connected to the main output.

Line-Level Talkback Outputs

The two line-level talkback outputs are intended to be connected to control rooms, production trailers, or other locations where talent-originated voice cues are required. The outputs are transformer balanced with a nominal level of $+4$ dBu. To enhance talkback audio quality, a compressor circuit controls the dynamic range of the signal coming from the microphone preamplifier.

For protection against accidental connection to cables that have DC power present, the line-level talkback outputs are capacitor coupled. In series with the talkback output leads are 300 ohm resistors, making the effective output impedance approximately 600 ohms. These resistors create a passive summing network, allowing talkback outputs on multiple Model 233 units to be connected ("bridged") together.

The line-level talkback outputs are connected by way of two 3-pin male XLR-type connectors which are located on the Model 233's back panel. The mating connectors (female) should be prepared so that signal high (+ or hot) is provided on pin 2. Signal low (– or cold) should be provided on pin 3. The cables' shields can be connected to pin 1. But, like the main output, in order to minimize the chance that ground-interaction problems will arise, pin 1 on the line-level talkback output connectors are isolated from the Model 233's chassis and circuitry. By making pin 1 "float," often-feared "ground loop" problems shouldn't arise. Note that the metal shell of the mating connector must also be "floating."

The line-level talkback outputs are intended to drive the lengthy cable runs that

are often part of broadcast and production audio applications. While the output circuitry is not intended to be “on-air” quality, overall audio performance should be very good. Devices connected to the line-level talkback outputs can range from amplified loudspeakers, analog inputs on intercom systems, and input channels associated with audio consoles. Connecting the outputs to devices that allow easy control of the signal level can be helpful. For example, connecting to spare input modules on an audio console provides the flexibility to add gain or attenuate as required. Dedicated talkback-associated outputs on the audio console can then be routed to the final destination(s).

As previously mentioned, the line-level talkback outputs on multiple Model 233 units can be directly connected together. Using a simple “Y” or “W” cable, this passive summing (adding together or “bridging”) of talkback signals allows one audio cable to serve as a master talkback path. A side effect from using this passive summing technique is that signal attenuation will occur. The audio quality won’t suffer, but an audio “pad” is created. If two line-level talkback outputs are connected together, a signal attenuation of 6 dB can be expected. Connecting three talkback outputs together will result in 9.5 dB of attenuation. And four talkback outputs “malted” together will lead to 12 dB of attenuation. In most cases this attenuation won’t pose a problem. Typically a device that receives the talkback signal, such as an amplified loudspeaker, will have an adjustable input sensitivity so this attenuation won’t prove to be a problem.

Line Inputs

The Model 233 allows two line-level audio sources to be connected. These sources

can be individually routed to the left channel, right channel, or both the left and right channel of the headphone outputs. The inputs are balanced, transformer-coupled with a nominal impedance of 10 k ohms. Capacitors, in series with the transformer’s input leads, prevent a DC voltage present on a connected source from impacting performance. The line inputs are compatible with signals that have a nominal level of –12 dBV to +6 dBu. Two trim potentiometers, located on the bottom of the Model 233’s enclosure, allow signals over this wide nominal level range to be effectively utilized.

Audio sources are connected to the line inputs by way of 3-pin female XLR-type connectors which are located on the unit’s back panel. Prepare the mating connectors (males) so that pin 2 is signal high (+ or hot), pin 3 is low (– or cold), and pin 1 is shield. If connecting a source in this manner results in hum or noise, it’s possible that removing the shield connection from pin 1 can eliminate the issue. With an unbalanced source connect pin 2 to signal high (+ or hot) and both pins 1 and 3 to shield. If connecting an unbalanced source in this manner results in hum or noise, connect pin 2 to high (+ or hot) and pin 3 to shield; leave pin 1 unterminated.

Intercom Interface

The Model 233’s intercom interface is designed to directly connect with standard single- and dual-channel party-line intercom lines. The one or two audio signals provided by the intercom line can serve as audio sources for the headphone outputs. Each signal can be individually assigned to the left channel, the right channel, or both the left and right channels. The Model 233 can also be configured to send talkback audio to either or both of the

intercom channels. In addition, the intercom line can provide the DC power required to operate the Model 233's circuitry.

An intercom line is connected to the Model 233 by way of a 3-pin female XLR-type connector which is located on the back panel. The mating connector (male) should be wired so that common is on pin 1, DC with channel 1 audio is on pin 2, and channel 2 audio is on pin 3. With single-channel intercom lines common is on pin 1, DC power is on pin 2, and audio is connected to pin 3.

The Model 233's intercom interface is directly compatible with broadcast and production party-line intercom lines associated with systems from manufacturers such as RTS and Clear-Com. Intercom lines associated with other systems should be equally compatible. RTS TW series systems are normally interfaced using 3-pin XLR-type connectors. These connectors are wired with common on pin 1, DC power and channel 1 audio on pin 2, and channel 2 audio on pin 3. With many Clear-Com systems, common is on pin 1, DC power is provided on pin 2, and audio is provided on pin 3.

The DC power supplied by the connected intercom line is generally sufficient to operate the Model 233's circuitry. The acceptable input range is 24 to 32 volts, with a required current of 125 milliamperes. Note that the specified input voltage is given when measured directly at the Model 233's intercom input connector (with the connector terminated on the Model 233) and not at the source of the intercom system's power.

External Power Input

An external source of 24 volt DC power can be connected to the Model 233 by way of a 2.1 x 5.5 mm coaxial power jack which is located on the back panel of the unit. The center pin of the jack is the positive (+) connection. While the requirement for the external source is nominally 24 volts, correct operation will take place over a 20 to 30 volt range. The Model 233 requires 90 milliamperes at 24 volts DC for correct operation. Included with each Model 233 is a 24 volt DC external power supply. The power supply's DC output cable has been terminated with a Switchcraft® S760K coaxial power plug. This "locking" type of plug correctly mates with the Model 233's 24 Vdc input jack. The locking feature is important, allowing the external power source to be securely attached to the Model 233.

As previously discussed in this user guide, an intercom line connected to the Model 233 can serve as the unit's power source. Alternately, an external 24 volt DC source can be connected. For redundancy, the intercom line and the external source can be connected at the same time. If one of them becomes inoperative the remaining source will provide power for the Model 233.

The Model 233's circuitry establishes the priority in which the unit draws its operating power. If an external source of 24 volt DC power is connected, it will always serve as the primary source. This minimizes the impact that the unit's power draw could have on a connected intercom line. If no external source of 24 volt DC is connected then power will be drawn from the intercom line. And, of course, no matter which source is providing power full operation of the intercom interface can take place.

Pushbutton Labeling

The three pushbutton switches used in the Model 233 were selected for several reasons. Foremost was the fact that they are highly reliable, using gold-plated contacts for long life in less-than-ideal environments. A second reason was that applying customized labels to the button caps would be very simple. The labels, text printed on clear material, are placed under the clear caps on the top of the buttons.

From the factory the left button is labeled COUGH, the center button is labeled TALKBACK 1, and the right button is labeled TALKBACK 2. This was selected to be appropriate for many on-air applications in English-speaking locations. But it's expected that these may need to be changed to meet the needs of specific applications.

As a "head start" for some applications, a clear sheet with a number of commonly used button designations printed on it is included in the shipping carton. These were created at the factory using a standard personal computer graphics program and laser printed onto 3M CG3300 transparency film. The desired button labels can be cut out with a pair of scissors, following the printed guide lines that indicate the required size.

The clear lens on top of each button cap can be removed with a fingernail or small screwdriver. Be certain not to scratch the button if a screwdriver or other small tool is used. The clear label can be removed and replaced. The button cap is then snapped back into the top of the button housing using finger-pressure only. No tool is required to replace the button cap.

If you need to make your own labels the process is quite simple. Use a personal

computer to create the desired text. The finished label size should be 0.625-inches (15.8 mm) square. The completed artwork can then be printed on transparency film sheets using a laser or inkjet printer. These sheets are readily available from most office supply stores. A pair of scissors or an X-ACTO® knife will complete the task.

Configuration

For the Model 233 to support the needs of specific applications a number of operating parameters must be configured. These include microphone preamplifier gain, phantom power on/off, headphone source and output mode selection, and operating modes. One 12-position and three 8-position DIP-type switch assemblies are used to establish the desired configuration. These switch assemblies are referred to as SW1 through SW4, with individual switches designated as SW1-1, SW1-2, etc. The switch assemblies are accessed through openings in the bottom of the Model 233's enclosure. The enclosure does not have to be disassembled to gain access to the switches.

To prevent unauthorized personnel from changing the configuration settings, a security plate is attached to the bottom of the Model 233's enclosure. For convenience, attached to the security plate is a configuration settings label. It provides a summary of the configurable parameters and related information. Refer to Appendix A for a representative view of the label. The security plate is held in place by means of four rubber bumpers ("feet") that have built-in screws. Using your fingers, remove the four bumpers so that the plate can be removed. Refer to Figure 3 for a detailed view of the configuration switch assemblies.

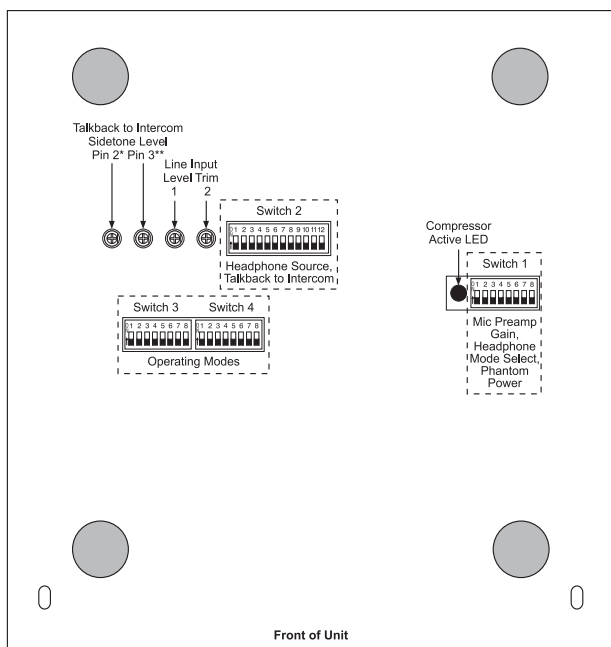

Figure 3. Bottom view of Model 233 showing configuration switches, trim pots, and compressor active LED

Microphone Preamp Gain and Phantom Power

Five switches are used to set the gain of the microphone preamplifier. One switch is used to select the on/off status of the phantom power supply.

Microphone Preamp Gain

Switches SW1-1 through SW1-5 are used to select the gain of the microphone preamplifier. The choices are 20, 30, 40, 50, and 60 dB. Only one switch should be enabled at a time. There's no problem changing the gain setting while the unit is operating. Audio clicks or pops might occur during gain transitions, but this shouldn't be a major issue as long as associated monitor loudspeakers are temporarily attenuated or muted.

Selecting the correct amount of gain for an application might take a little experimentation. The goal is to bring the microphone's

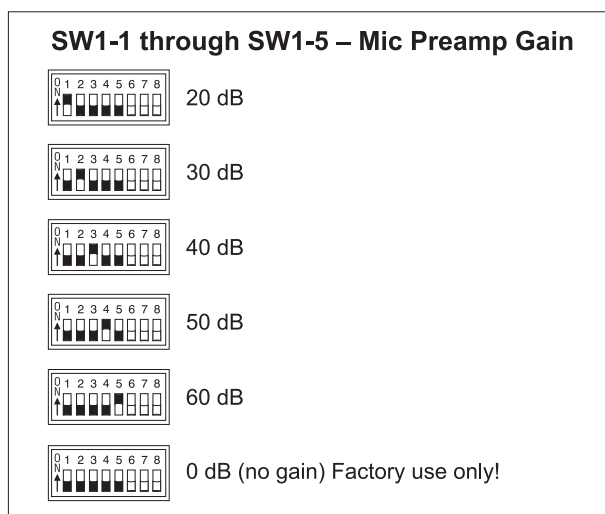

Figure 4. Microphone preamplifier gain switch settings

signal up to line level, nominally -2 dBu, on the Model 233's main output. Operating at this signal level will help to ensure the delivery of "clean" audio to the connected device. The output of the Model 233's microphone preamplifier is used by both the main output and, by way of the compressor circuit, the talkback functions. So creating a nice "hot" signal will help maintain audio quality, specifically the signal-to-noise ratio, when driving the often-lengthy cable runs.

Unfortunately, there's no "perfect" gain setting that this guide can recommend. The two issues that impact the setting are output sensitivity of the connected microphone and the acoustical output level of the microphone's user. With some headset microphones, such as the Sennheiser HMD25, selecting an initial setting of 40 dB is appropriate. Users who speak loudly might need to have the gain reduced to 30 dB. Quiet users might need 50 dB of gain.

An LED indicator is provided as an aid in correctly setting the gain of the microphone preamplifier. Red in color, this LED is located adjacent to switch assembly 1.

It is visible by observing the bottom of the Model 233's enclosure when the security plate has been removed. Technically, this red LED lights whenever the compressor circuitry is controlling the dynamic range of the signal coming from the microphone preamplifier. The threshold is set to be 2 dB above the Model 233's nominal internal operating level. So a good "rule of thumb" is to adjust the gain of the microphone preamplifier so that the compressor active LED lights ("flashes") when the connected microphone is sending signal peaks. During normal operation the LED should not remain fully lit when typical audio signals are present on the mic input.

It's important to remember that the compressor active LED is used to assist in setting the mic preamplifier gain to the optimal value. It doesn't necessarily indicate that the main output's signal is being compressed. Unless specifically configured to perform otherwise, the output of the compressor is only used for the talkback output functions.

It's expected that the 20 and 60 dB gain settings will not often be used. But there are always exceptions and that's why they were included. It's possible that with a very "hot" microphone, such as a phantom-powered condenser-type, 20 dB of gain could be correct. It's also possible that a microphone with a very low level output, such as a ribbon-type, would need 60 dB of gain. But in general, the 30, 40, and 50 dB gain settings will serve most applications.

Note that if no gain switch is set to its active (on) position the Model 233's preamplifier will operate at unity (0 dB) gain. In this mode the preamplifier will remain stable, but is intended only for use during factory testing. A valid exception would be where

a line-level signal is connected to the microphone input. This could occur with a special Model 233 application. But with a microphone connected as the input source one should never use the 0 dB setting. The issue is that with no gain added to the microphone input signal the relative noise floor on the circuitry associated with the main output and talkback functions will be much too high. These circuits are designed for handling line-level signals, expecting to receive audio from the output of the microphone preamplifier. In conclusion, the 0 dB gain setting doesn't highlight a problem, but simply reflects the unit's gain structure.

Phantom Power On/Off

The Model 233 can provide nominal 48 volt phantom power to the microphone input. Switch SW1-8 controls whether or not phantom power is active. By phantom power's very nature it could be left applied to the microphone input at all times. But generally people prefer to turn it off unless required for a specific microphone.

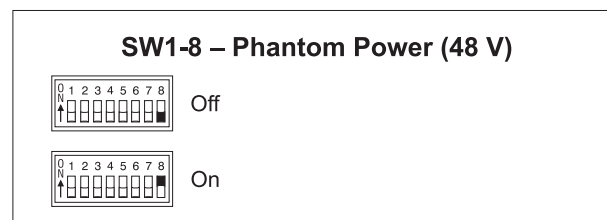
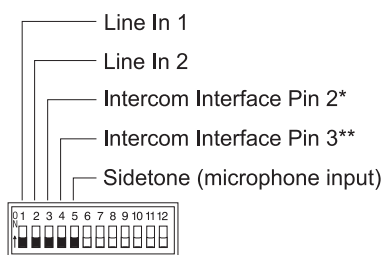

Figure 5. Phantom power switch settings

Headphone Source Selection

Switch assembly SW2 is used to configure the sources that are routed to the stereo headphone output. Five headphone sources are available: line input 1, line input 2, intercom channel 1, intercom channel 2, and sidetone. Each of these sources can be assigned to the left, right, or both the left and right channels of the stereo headphone output.

SW2-1 through SW2-5 – Left Channel Headphone Source Selection



On to enable source; multiple sources will sum

* RTS™ TW Channel 1

** RTS™ TW Channel 2, Clear-Com® Channel 1

SW2-6 through SW2-10 – Right Channel Headphone Source Selection

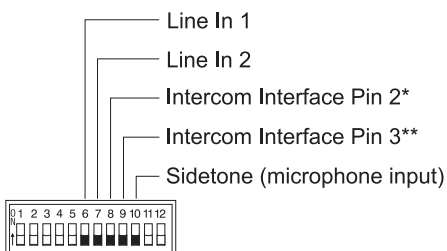

On to enable source; multiple sources will sum

* RTS™ TW Channel 1

** RTS™ TW Channel 2, Clear-Com® Channel 1

Figure 6. Left and right channel headphone source selection settings

The line inputs are interfaced using two connectors also located on the back panel. Associated with line inputs 1 and 2 are level trim potentiometers. They are provided so that audio sources with a wide range of nominal levels can be effectively used as cue sources. Please refer to the Advanced Operation section of this user guide for details on using the trim pots.

Audio associated with intercom channels 1 and 2 is provided by way of the intercom interface whose connector is also located

on the back panel. Two trim pots are associated with the intercom channels. They allow adjustment of the intercom sidetone (null) level. This impacts the amount of talkback audio signal that is returned to a headphone output when a talkback-to-intercom function is active.

The sidetone audio source comes from the output of the compressor circuit associated with the microphone preamplifier. This allows an announcer or other Model 233 user to receive a confirmation signal of what is coming out of the main, and if configured, talkback outputs.

As previously discussed, each of the available input sources can be assigned to the headphone output's left channel, right channel, or both the left and right channels. The Model 233's circuitry allows any combination of input assignments to be made. For example, consider the situation where a single-channel intercom line, with audio present only on pin 3, is connected. In this case it may be desirable to assign this intercom audio source to both the left and right channels. This would entail setting switches SW2-4 and SW2-9 to their on positions. All other switches would remain in their off positions.

A more complex application might have a broadcast-type 2-channel IFB circuit connected to the intercom input and a line-level audio signal from a golf event "spotter" connected to line input 1. In a case such as this, it would be typical for IFB channel 1 to be assigned to the headphone's left channel, IFB channel 2 assigned to the right channel, and line input 1 also assigned to the right channel. This would allow both IFB channel 2 and "spotter" audio to be heard in the headphone's right-channel output. To achieve this would require that switches SW2-3,

SW2-6, and SW2-9 be placed in their on positions.

Note that in some cases a user may wish to wear a headset or a pair of headphones in a left/right orientation opposite of what's usual. In this situation the transducer designated for the left ear would actually supply audio to the user's right ear, and vice versa. A specific application where this occurs is when on-air talent needs to have a headset's boom microphone come across the right side of their face, rather than the more-typical left side. In this case it's important to select the left- and right-channel headphone source assignment accordingly. With the Model 233's flexible source selection there's no reason why users, such as on-air talent, shouldn't have their cue sources assigned correctly.

Special applications may benefit by using the Model 233 in a 3-channel headphone output mixer mode. This is accomplished by first configuring the headphone output to monaural. (Details on how to accomplish this are described later in this section of the user guide.) Next the cue source whose level is to be adjusted by the rotary control on the far left side of the front panel is assigned to the left channel. Finally, the cue source whose level is to be adjusted by the center control is assigned to the right channel. During operation the user will create their desired cue mix using these two front-panel controls.

There may also be cases where a monaural "single-muff" headset or headphone will be connected to the Model 233's headphone output. In this case the desired source must be routed only to the left channel. This is because the 2-conductor plug that's typically associated with a mono headset or headphone

will connect only to the tip lead (left channel) of the headphone output. Signals assigned to the right channel will not be heard by the user.

Headphone Output Mode

Switch SW1-6 allows a monaural headphone output to be created. This is accomplished by summing (adding) the selected left- and right-channel cue signals. The combined signals are sent to both the left- and right-channel headphone output driver circuits. The outputs of these circuits connect, by way of 51 ohm series protection resistors, to the headphone output jack.

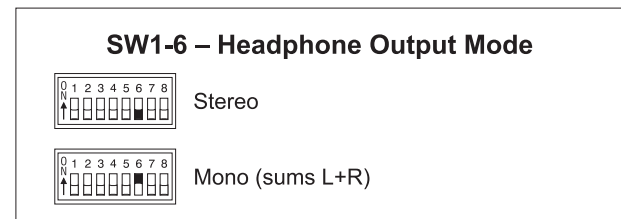

Figure 7. Headphone output mode settings

The headphone output monaural mode feature was specifically included so that a 3-channel headphone mixer mode can be created. By enabling the mono mode, the three front-panel user level controls ("pots") can be used to create the desired "mix" of signals being sent to the headphone outputs. Many, many applications, especially in production settings, can benefit from this capability. The desired cue sources must be carefully assigned to take advantage of the monaural mode. The first cue source should be assigned, using the DIP-type switches, to the far left channel. Its output level will be adjusted by the left control. The second cue source should be assigned to the right channel. Its output level will be adjusted by the far right control. A third cue signal, sidetone, can also be enabled. The sidetone level

control, located on the far right, will be used to adjust its level.

There is one limitation related to the headphone output mode. It's the fact that the output will be 2-channel monaural. Whatever signal is present on the headphone output's left channel will also be present on the right channel. (The exception is if the right-channel output is disabled.) A stereo headphone mix can't be created. But in most cases this limitation won't overshadow the benefit of being able to create the mix. For signal-flow clarification please review the block diagram located at the end of this user guide.

Operating Modes

The sixteen switches associated with switch assemblies SW3 and SW4 are used to configure the Model 233's operating modes. Technically, these switches "talk" to the microcontroller integrated circuit and associated software that give the Model 233 its "smarts." The software has been carefully designed to provide a number of different ways in which the unit can function. It's critical to carefully review the available options and choose the ones that best meet the needs of a specific application. Note that switches can be changed even while the Model 233 is powered up and operating. The unit's operating characteristics will change in "real-time" in response to configuration changes.

In addition to the switch assemblies SW3 and SW4, the last two positions of switch assembly SW2 are used for configuration. Specifically, SW2-11 and SW2-12 are used for the talkback to intercom functions.

Main Output Button Mode

Switches SW3-1 and SW3-2 configure how the main output button functions.

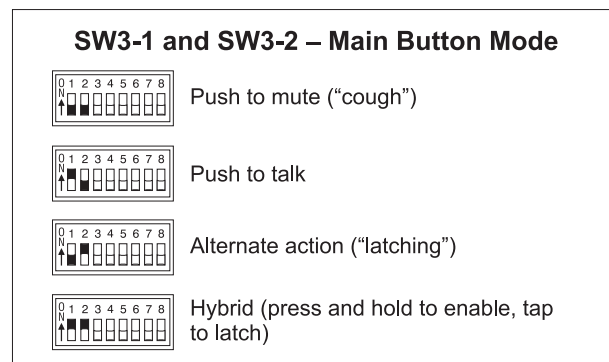

Figure 8. Main output button mode settings

There are four available modes:

- **Push to mute:** In this mode the main output is normally active. The main output will mute whenever the button is pressed and held. This is the "cough" mode typically used for on-air sports broadcasting applications.
- **Push to talk:** In this mode the main output is normally muted. The main output will become active whenever the button is pressed and held.
- **Alternate action:** In this mode the main output will change between its active and muted state whenever the button is pressed. Upon power up the main output will be in its muted state.
- **Hybrid:** This mode is a combination of push to talk and alternate action. It's similar to the way talk buttons function on user stations associated with broadcast and production intercom systems. If the button is pressed and held, the main output will become active until the button is released. If the button is momentarily "tapped" the main output will change state. Upon power up the main output will be in its muted state.

Talkback 1 Button Mode

Switch SW3-3 configures how the talkback 1 button functions.

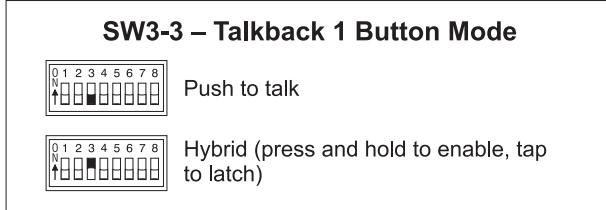

Figure 9. Talkback 1 button mode settings

Two modes are available:

- **Push to talk:** In this mode the talkback 1 button is normally off. The function becomes active whenever the button is pressed and held.
- **Hybrid:** This mode is a combination of push to talk and alternate action. If the button is pressed and held, the talkback 1 button will become active until the button is released. If the button is momentarily “tapped” the state will change. Upon power up the talkback 1 button will be in its off state.

Talkback 2 Button Mode

Switch SW3-4 configures the way the talkback 2 button functions.

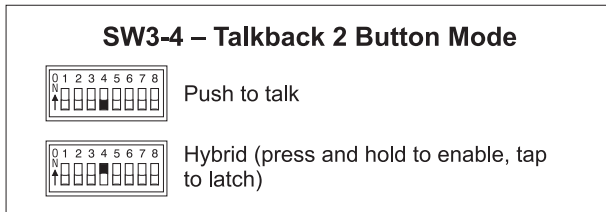

Figure 10. Talkback 2 button mode settings

Two modes are available:

- **Push to talk:** In this mode the talkback 2 button function is normally off. The function will become active whenever the button is pressed and held.
- **Hybrid:** This mode is a combination of push to talk and alternate action. If the button is pressed and held, the talkback 2 button will become active until the button is released. If the button is momentarily “tapped” the state will change. Upon power up the talkback 2 button will be in its off state.

Talkback 1 Button Function

Switch SW3-5 configures the overall operation of the button associated with talkback 1.

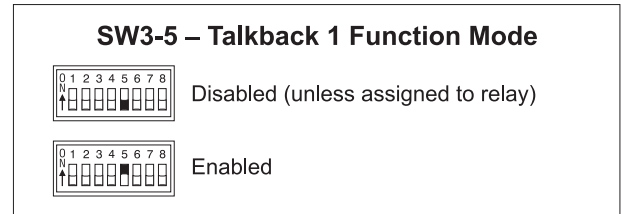

Figure 11. Talkback 1 function mode settings

Two modes are available:

- **Disabled:** In this mode the talkback 1 button is disabled. The talkback 1 line-level output and, if configured, talkback to intercom pin 2 function, will never be active. An exception is if the auxiliary relay is configured to follow the status of the talkback 1 button. In this case the talkback 1 button will only control the relay.
- **Enabled:** In this mode the talkback 1 button will operate normally. Whenever the button is active the line-level output and, if configured, the talkback to intercom pin 2 function, will be active.

Talkback 2 Button Function

Switch SW3-6 configures the overall operation of the button associated with talkback 2.

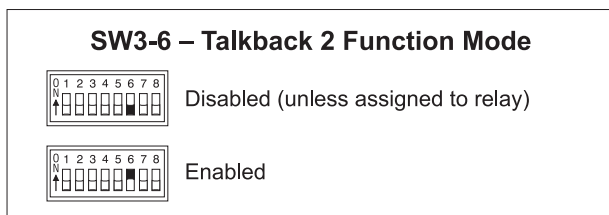

Figure 12. Talkback 2 function mode settings

Two modes are available:

- **Disabled:** In this mode the talkback 2 button is disabled. The talkback 2 line-level output and, if configured, talkback to intercom pin 3 function, will never be active. An exception is if the auxiliary relay is configured to follow the status of the talkback 2 button. In this case the talkback 2 button will only control the relay.
- **Enabled:** In this mode the talkback 2 button will operate normally. Whenever the button is active the line-level output and, if configured, the talkback to intercom pin 3 function, will be active.

Main Output Source

Switch SW3-7 is used to select which audio source is routed to the main output. The choices are the output of the microphone preamplifier or the output of the compressor circuit. For most on-air applications the output of the microphone preamplifier is the desired source. This will provide the most natural audio quality with the potential for a large amount of dynamic range.

In some applications it may be desirable for the output of the compressor circuit to be routed to the main output. Appropriate

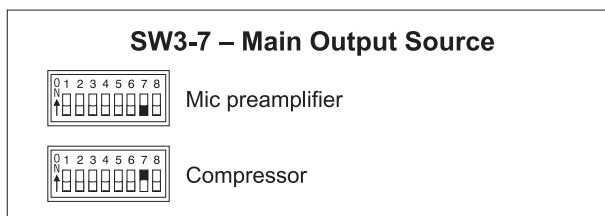

Figure 13. Main output source settings

applications could include on-air broadcast situations where nonprofessional talent is present. Controlling the dynamic range of the audio signals on the main output can limit the chance of cable cross-talk and equipment overload. Another typical application where using the output of the compressor would be appropriate when the Model 233's system mode is selected for production. In this case the main output would be used as an additional talkback output and dynamic range control would be beneficial.

Sidetone Mode

Switch SW3-8 configures the way the sidetone function operates.

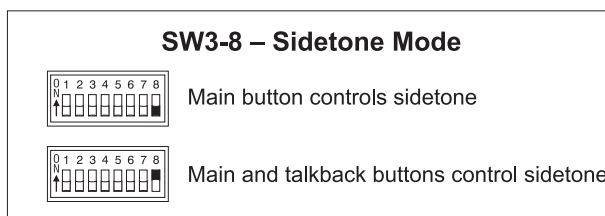

Figure 14. Sidetone mode settings

Two modes are available:

- **Main Button:** In this mode the sidetone function will only be active when the main output is active.
- **Main and Talkback Buttons:** In this mode the sidetone function will be active whenever the main, talkback 1, or talkback 2 outputs are active.

Headphone Output Operating Modes

The user is provided with three rotary level controls (“pots”) that are associated with the headphone output. Switches SW4-1, SW4-2, and SW4-3 are used to configure the way two of the controls, the one located on the far left and the one located in the center, function. (These settings don’t impact operation of the sidetone level control which is located on the far right.) With just these three switches a wide range of operating modes can be configured. Carefully reviewing the capabilities of the available functions may prove worthwhile.

Dual-Channel or Stereo Mode

Switch SW4-1 is used to select whether the control located on the far left and the control located in the center provide a dual-channel (“level/level”) or stereo (“level/balance”) mode of operation. In the level/level mode these two controls operate independently, each controlling the level of one of the headphone output channels. This mode is generally used for on-air broadcast applications where independent cue signals are provided to the left- and right-headphone channels. In the level/balance mode the control on the far left sets the overall output level for both headphone channels. The center control is used to adjust the balance (the relative levels) of the left and right channels. This mode is generally best suited for applications where a stereo cue source is being provided.

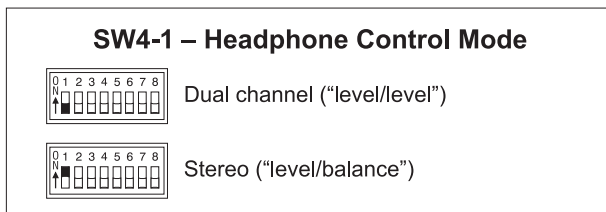

Figure 15. Headphone control mode settings

Reverse Left/Right Mode

Switch SW4-2 is used to select whether two of the rotary controls are in the normal or reverse left/right mode of operation. When selected to the normal mode, and level/level mode is also selected, the control on the far left adjusts the level of headphone output’s left channel. (This is the signal that appears on the tip lead of the ¼-inch 3-conductor jack.) The center control adjusts the level of the right channel. When selected to the normal mode, and the level/balance mode is also selected, turning the balance control in the counterclockwise direction increases the perceived level of the left channel, and vice versa.

As you may have already guessed, when selecting the reverse left/right mode of operation everything is reversed! To be more specific, when selected for reverse mode, and the level/level mode is also selected, the control on the far left adjusts the headphone output’s right channel (output jack’s ring lead) while the control in the center adjusts the left channel. When selected to the reverse mode, and the level/balance mode is also selected, turning the balance control in the counterclockwise direction increases the perceived level of the right channel, and vice versa.

The reverse mode is provided specifically for cases where a headset’s left and right earpieces are placed on a user’s head in a reverse orientation. This ensures that the

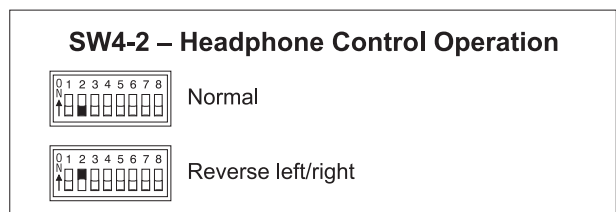

Figure 16. Headphone control operation settings

user is provided with a consistent and easy-to-use set of headphone level controls.

Minimum Level Mode

Switch SW4-3 is used to configure the minimum headphone output level for the controls located on the far left and center. (This setting doesn't impact operation of the sidetone level control which is located on the far right.) In the -40 dB mode the minimum output level for the control on the far left and the control in the center is 40 dB below maximum; the outputs will never fully mute. This ensures that any cue audio signals present on the selected Model 233 inputs will always be present on the headphone output. In most on-air broadcast applications this is the appropriate setting.

When the full mute mode is selected and the level/level mode is also selected, moving the control on the far left or the control in the center to their fully counterclockwise positions will cause their associated channel to fully mute. (This is identical to how the sidetone control, located on the far right, always functions.)

When the full mute mode is selected and the level/balance mode is also selected, turning the control configured for level to its fully counterclockwise position will cause both headphone channels to mute.

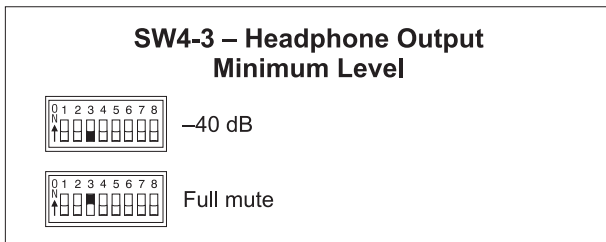

Figure 17. Headphone output minimum level settings

Turning the control assigned to be the balance control to either its fully clockwise or fully counterclockwise position will cause the appropriate channel to mute.

Selecting the full mute mode may be appropriate for applications where minimizing the chance of audio "leakage" is important. This could occur when the connected headset or headphones are at times placed on a desk or tabletop.

Main Button Mode

Switch SW4-4 is used to configure how the main button responds to talkback activity. Specifically it applies only when the system is selected to the on-air mode and the main output button mode has been configured for alternate action or hybrid. When the main button mode is set to normal and a talkback function is active, the main output will, if "latched" on, be temporarily placed in its off (muted) state. When the talkback function is no longer active the main output will return to its previous latched on state.

When the talkback forces main button to unlatch mode is selected, and a talkback function becomes active, the main output will, if latched on, be placed in its off (muted) state and the latch condition forced off. When the talkback function is no longer active the main output will remain in the latched off state.

The differences in how the main button modes impact operation and user comfort are relatively subtle. The nuances of both

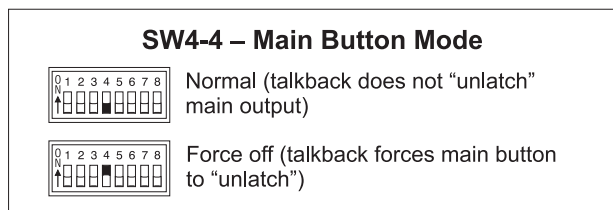

Figure 18. Main button mode settings

modes should be considered before a final selection is made. If possible, experimenting with both modes in a test environment might prove to be very helpful.

Relay Mode

Switches SW4-5 and SW4-6 configure the operating mode of the auxiliary relay.

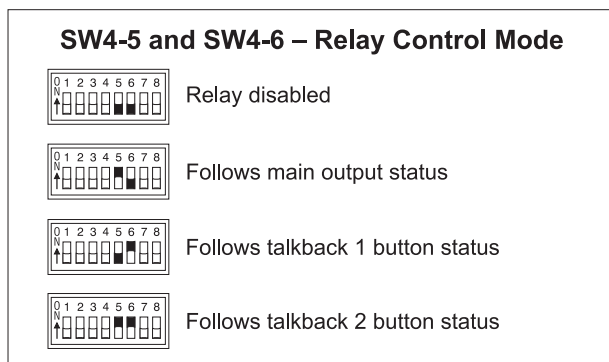

Figure 19. Auxiliary relay control mode settings

Four modes are available:

- **Relay disabled:** In this mode the relay is disabled and will never change state.
- **Follows main output status:** In this mode the relay will follow the state of the main output. Specifically, the relay will change state (energize) whenever the main output is active.
- **Follows talkback 1 button status:** In this mode the relay will follow the state of the talkback 1 button. Specifically, the relay will change state (energize) whenever the button is active.
- **Follows talkback 2 button status:** In this mode the relay will follow the state of the talkback 2 button. Specifically, the relay will change (energize) state whenever the button is active.

System Mode

Switches SW4-7 and SW4-8 are used to configure the overall operating mode of the Model 233. Understanding how the three modes impact overall system operation will ensure that correct operation and maximum usability will occur. When selected to the on-air mode, the main output will mute whenever a talkback function is active. The LED indicators associated with the main output will light accordingly. The on-air mode should be selected for all on-air broadcast applications. It's imperative that the main output be muted whenever on-air talent is using one of the talkback functions to communicate with production personnel.

The stadium announce mode is very similar to the on-air mode with one important addition. Whenever the main output is active the external sources assigned to the left and right headphone outputs will mute. This ensures that an announcer won't be distracted at an inopportune time by audio signals arriving from the line inputs or intercom interfaces. It's important to note that the stadium announce mode will not impact the headphone sidetone function.

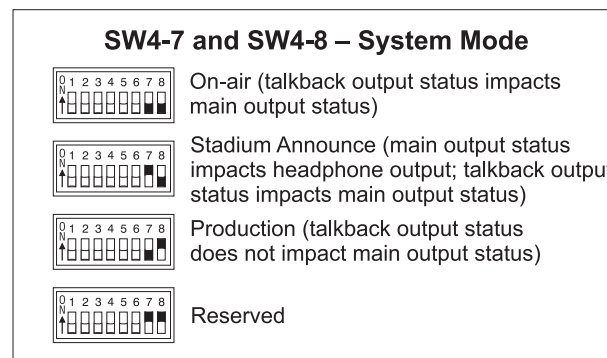

Figure 20. System mode settings

When configured for the production mode, the main output is never muted in response to a talkback function being active. The main output will be controlled only by the main output pushbutton. This mode allows the main output to be used, for example, as an additional talkback output. In this way, the main output and talkback output functions can be used independently with neither impacting the other. This also allows all three buttons to be used simultaneously. Note that as is always the case the audio source for the main output is, depending on its configuration, either the output of the microphone preamplifier or the output of the compressor.

In summary, when selected for the correct application, each of the system modes can prove equally valuable. A thorough study of how they impact the Model 233's operation can lead to many interesting and powerful uses.

Talkback to Intercom Functions

The last two switches in switch assembly SW2 are used to configure the talkback to intercom functions.

Talkback 1 to Intercom Function Mode

Switch SW2-11 configures whether the talkback 1 button will allow talkback audio to be sent to pin 2 of the intercom interface.

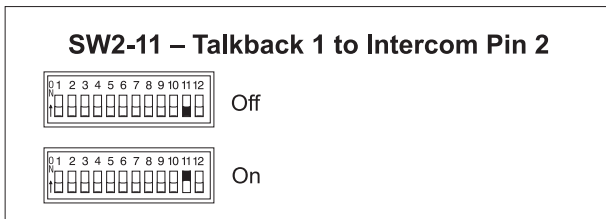

Figure 21. Talkback 1 to intercom pin 2 settings

Two modes are available:

- Disabled: In this mode the talkback 1 button will not allow talkback audio to be sent to pin 2 of the intercom interface.
- Talkback 1 to intercom interface pin 2: In this mode the talkback 1 button will control the routing of talkback audio to pin 2 of the intercom interface. Pin 2 is channel 1 of an RTS intercom system.

Talkback 2 to Intercom Function Mode

Switch SW3-12 configures whether the talkback 2 button will allow talkback audio to be sent to pin 3 of the intercom interface.

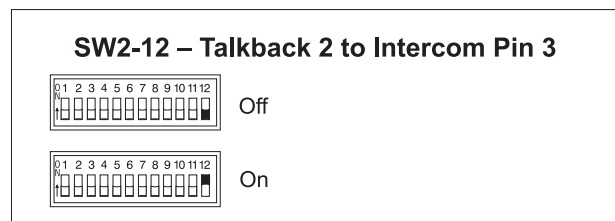

Figure 22. Talkback 2 to intercom pin 3 settings

Two modes are available:

- Disabled: In this mode the talkback 2 button will not allow talkback audio to be sent to pin 3 of the intercom interface.
- Talkback 2 to intercom interface pin 3: In this mode the talkback 2 button will control the routing of talkback audio to pin 3 of the intercom interface. Pin 3 is channel 2 of an RTS TW intercom system. For a single-channel Clear-Com intercom system pin 3 is channel 1.

Conclusion

Once the eighteen switches have been set to the desired Model 233's operating configuration, it may be time to reattach the security plate. The exception is if the trim pots associated with the line inputs and intercom sidetone (null) need to be adjusted. Details are provided later in this user guide. The plate attaches using the four rubber bumpers. They should be hand-tightened only; no tools are to be used.

Operation

At this point the desired input, output, and power connections should have been made. The button labels may have been revised. After carefully reviewing the application, the configuration switches should have been set. Normal operation of the Model 233 can now begin. The unit will begin functioning as soon as a power source is connected. As previously discussed, power for the Model 233 can be provided by an intercom line or an external source of 24 volt DC. It's important to highlight the fact that the Model 233 is an active device. Audio signals will not be present on the outputs unless power has been supplied. Specifically, the microphone does not passively "cut through" to the main output connector!

Upon Model 233 power up, the four status LEDs will light in succession as a firmware "boot up" indication. The unit will then begin normal operation. Depending on the selected configuration, one LED associated with the state of the main output may be lit. The user is now presented with three buttons, four LEDs, and three rotary controls. These are simple to operate and understand, as will be described in the following paragraphs.

Pushbutton Switches and Status LEDs

Three pushbutton switches are used to control the main output and the talkback functions. The way each operates depends on the selected configuration. Four LED indicators are located adjacent to the buttons. They reflect the status of the main output and talkback functions.

Main Output Button and LED Indicators

The button on the left, factory labeled as COUGH, functions according to the selected configuration. Two LED indicators, located directly above the button, are associated with the status of the button and/or the main output. If the Model 233 is set to either the on-air or stadium announce mode the green LED, located on the right, is lit whenever the main output is active. This could be considered as an "on-air" or mic active indicator. At the least it should serve as a "careful what you say" warning! The red LED, located on the left, will be lit whenever the main output is muted. This indicates that it's safe to speak as one sees fit.

If the Model 233's system mode is configured for production the red LED will never light. This is to reflect the fact that the main output button has now taken on a function similar to that of one of the talkback buttons. To clarify, when the Model 233 is set to the production mode the red LED will never light while the green LED will light whenever the main output is active.

Main Output Button Modes

If the Model 233 is set for the on-air or stadium announce mode:

- **Push to mute:** If this mode is selected the main output is normally active. The main output will mute whenever the button is pressed and held.

- **Push to talk:** If this mode is selected the main output is normally muted. The main output will become active whenever the button is pressed and held.
- **Alternate action:** If this mode is selected the main output will alternate between its active and muted states whenever the button is pressed. Upon power up the main output will be in its muted state.
- **Hybrid:** This mode is a combination of push to talk and alternate action. It is similar to the way that talk buttons function on user stations associated with broadcast or production intercom systems. If the button is pressed and held the main output will become active and remain active until the button is released. If the button is momentarily “tapped” the main output will change state. Upon Model 233 power up the main output will be in its muted state.

Talkback activity will always cause the main output to be placed in its off state. If the main output was in the “latched” on state when talkback began, once talkback activity ends that state will resume; the main output will again be in its on (“latched”) state.

Talkback 1 Button and LED Indicator

The button in the center, factory labeled TALKBACK 1, controls the function(s) associated with talkback 1. The manner in which the button functions depends on the way it was configured. An LED indicator, green in color, is located directly above the button. It lights whenever talkback 1 is active. If the talkback 1 function mode has been configured for disabled, it will light only if the auxiliary relay has been assigned to follow the talkback 1 button.

If the Model 233 has been selected to the on-air or stadium announce system mode, whenever talkback 1 is active the main output will be placed in the muted state. If the Model 233 is set to the production system mode the status of talkback 1 will not impact the main output.

Talkback 1 Button Modes

- **Push to talk:** If this mode is selected the function(s) associated with the talkback 1 button is normally off. The function(s) will become active whenever the button is pressed and held.
- **Hybrid:** This mode is a combination of push to talk and alternate action. If the button is pressed and held, the function(s) associated with the talkback 1 button will become active until the button is released. If the button is momentarily “tapped” the function(s) will change state. Upon Model 233 power up talkback 1 will be in its off state.

Talkback 2 Button and LED Indicator

The button on the right, factory labeled TALKBACK 2, controls the function(s) associated with talkback 2. The manner in which the button functions depends on how it was configured. An LED indicator, green in color, is located directly above the button. It lights whenever talkback 2 is active. If the talkback 2 function mode has been configured for disabled, it will light only if the auxiliary relay has been assigned to follow the talkback 2 button. If the Model 233 is selected to the on-air or stadium announce system mode, whenever talkback 2 is active the main output will be placed in the muted state. If the Model 233 is set to the production system mode the status of talkback 2 will not impact the main output.

Talkback Output 2 Button Modes

- Push to talk: If this mode is selected the function(s) associated with the talkback 2 button is normally off. The function(s) will become active whenever the button is pressed and held.
- Hybrid: This mode is a combination of push to talk and alternate action. If the button is pressed and held, the function(s) associated with the talkback 2 button will become active until the button is released. If the button is momentarily “tapped” the function(s) will change state. Upon Model 233 power up talkback 2 will be in its off state.

Headphone Output Level Controls

Three rotary controls (“pots”) are located on the Model 233’s front panel and are associated with the stereo headphone output. The manner in which the controls function depend on the selected configuration. The control on the far right is associated with the sidetone function. It’s operation will be discussed in a later section. One configuration parameter sets the control on the far left and the control in the center to operate in a level/level or a level/balance mode. Another parameter allows the left/right assignment of the controls to be reversed. A third parameter selects whether the headphone output channels will maintain a minimum output level or can be fully muted. In most cases the headphone output will be configured for stereo, rather than monaural, operation. The following paragraphs will describe how these controls will function in that scenario.

Level/Level Mode

When set to the level/level mode, the control on the far left and the control in the center operate independently. Each

control sets the output level of one channel of the headphone output. If configured to the normal mode, the control on the far left is used to adjust the level of the headphone output’s left channel. The control in the center is used to adjust the level of the right channel. If configured to the reverse left/right mode, the control on the far left adjusts the headphone output’s right channel. The control in the center adjusts the left channel.

When in the level/level mode, and the minimum output level is set for –40 dB, turning each control to its fully counterclockwise position will place its respective output level 40 dB below its maximum. This setting ensures that talent will never be fully “isolated” from potentially important cue signals. If present on one of the Model 233’s inputs and assigned to the headphone channels, some audio signal will always be present on the headphone output. If set to the full mute mode, turning each control to its fully counterclockwise position will cause its respective output to fully mute.

The Model 233’s level controls have a mechanical step (detent) that is located at the halfway (50%) position of their rotation range. This is intended to serve as an aid to Model 233 users. In an ideal installation, setting the far left and center controls to their detent position will result in a comfortable headphone output level. The user, in response to a changing operating environment, can then move the controls to get more or less level as desired. The detent position will always remain as a useful reference point. To achieve this condition the audio level on the connected line inputs may have to be calibrated as required. This is somewhat counter to the usual mentality of just

providing the user with whatever level comes up by default. Spending a few extra minutes “trimming” the audio levels can result in much happier and more productive talent. As previously mentioned, a level trim potentiometer is associated with each line input. These may be helpful in achieving the desired adjustment range of these two level controls. Refer to the Technical Notes section of this user guide for details.

Level/Balance Mode

When set to the level/balance mode, the control on the far left and the control in the center operate together to adjust the headphone output level. The control on the far left adjusts the overall level of both the left and right channels. The balance control, located in the center, adjusts the relative left/right level balance. In this mode the controls operate in a manner reminiscent of a consumer audio amplifier or receiver. If set to the normal mode, rotating the balance control in the counterclockwise direction reduces the level of the right channel, providing the user with more perceived level in the left channel. If set to the reverse mode, rotating the balance control in the counterclockwise direction reduces the level of the left channel, providing the user with more perceived level in the right channel.

When in the level/balance mode and the minimum output level is set to -40 dB, turning the level control to its fully counterclockwise position will place both headphone output channels to 40 dB below maximum. This ensures that talent will never be fully “isolated” from potentially important cue signals. In addition, rotating the balance control to either its fully clockwise or fully counterclockwise position will cause the applicable channel to

be 40 dB below its maximum. If set to the full mute mode, turning the level control to its fully counterclockwise position will cause both the left and right channels to fully mute. In addition, rotating the balance control to either its fully clockwise or fully counterclockwise position will cause the applicable channel to fully mute.

Both of these controls have a mechanical step (detent) that is located at the halfway (50%) position of its rotation range. The balance control will typically be set to its center, detent position, making the level of the left and right channels equal. In an ideal installation, the level control can also be set to its detent position and provide a comfortable headphone output level. This will allow the user, in response to their preference or a changing environment, to adjust the level and balance controls as desired. The detent positions will always remain as a useful reference point. To achieve this condition the audio levels on the connected line inputs must be adjusted as required. Spending a few extra minutes “trimming” the connected audio levels, rather than just providing whatever happens to come up, should prove worthwhile. The result will be talent that is more relaxed, and an overall production that works more smoothly. As previously mentioned, a level trim potentiometer is associated with each line input. If the line inputs are utilized as cue sources, adjusting the trim pots may be helpful in achieving the desired adjustment range of the level controls. Refer to the Technical Notes section of this user guide for details.

Monaural Headphone Output Level Control Operation

As previously discussed, the headphone output can be set for monaural operation. This option is specifically provided so

that a headphone mix mode can be created. If this has been enabled, the three front-panel level controls are used as a cue source mixer. Independent cue inputs will be assigned to the control on the far left and the control in the center channel, serving as two of the mix sources. How these two controls respond when placed in their fully counterclockwise position will depend on the configuration. By default the output level will be 40 dB below its maximum level. An alternate configuration will make the outputs mute. The control on the far right, sidetone, will always maintain the same function. It is used to add signal associated with the microphone input to the headphone output as desired.

Sidetone Operation

As previously covered in this user guide, a sidetone function can be configured. Sidetone is defined as the user's own voice signal being returned to them as a headphone cue source. This helps the user create a more effective performance as well as possibly receiving an "on-air" or "you're live" indication. Depending on how it was configured, sidetone audio will be sent to the left headphone output, the right headphone output, or both the left and right headphone outputs. In addition, the side tone function can be configured so that it is active only when the main output is active, or whenever the main output or one of the talkback outputs is active. The level control on the far right adjusts the side-tone level. When the sidetone level control is in its fully counterclockwise position the sidetone signal will always be fully muted.

Astute readers will realize that sidetone audio can also be provided from the intercom cue sources during Model 233 talkback to intercom activity. This "passive" sidetone is created in the intercom interface's analog talk/listen hybrid sidetone (null) circuit. Trim pots allow the intercom sidetone level to be adjusted over a limited range. To get maximum performance when either or both intercom channels are used as a cue source one simple calibration process may need to be performed. This involves adjusting the sidetone (null) trim pots to their fully counterclockwise positions, providing minimum sidetone level. This will reduce the level "build up" that would occur when both the main and the intercom sidetone audio signals are sent to the headphone output. The goal is for the sidetone level to remain as constant as possible, no matter what function—main output, talkback-to-line-level output, or talkback-to-intercom—is active.

Stadium Announce Mode and the Headphone Outputs

When the system mode has been selected for stadium announce and the main output is active the input sources assigned to the left and right headphone outputs will automatically mute. As expected, in this state the level controls located in the left and center positions won't be active either. Once the main output returns to the muted state these two level controls will again become active. Operation of the sidetone function, including the sidetone level control, will not be impacted.

Advanced Operation

Adjusting the Line Input Trim Pots

As has been previously mentioned, associated with the two line inputs are trim pots that allow the input levels to be adjusted. The two trim pots are accessible by way of round openings in the bottom of the Model 233's enclosure. By adjusting these trim pots, signals with a nominal signal level of -12 dBV to $+6$ dBu can be effectively used as cue sources. Unfortunately, there are no definitive rules regarding how best to adjust the trim pots, but some suggestions may prove to be valuable. Depending on how the line inputs are utilized, the trim pots can be used to either adjust the absolute level of each line input signal, or to adjust the relative level of the signals when

compared to other sources. The following examples may provide some clarification.

Let's begin with an application that has a stereo cue source connected to the line inputs. The cue source selection switches are configured to create a stereo headphone output with line input 1 assigned to the left channel and line input 2 assigned to the right channel. Begin the trim pot adjustment process by moving the user level controls (located on the front panel) to their detent (50% of rotation) positions. Then, with the stereo cue source providing signal at its normal level, adjust the trim pots to provide a comfortable level to the connected headphones. The user can now, in response to changing conditions, adjust the front-panel level controls as desired. Returning the controls to their detent positions will always provide the "reference" level to the headphone output.

A second example has the intercom input and line input 1 both providing cue sources. Pin 2 of the intercom circuit supplies program-with-interrupt audio that is routed to the headphone output's left channel. Pin 3 of the intercom circuit supplies program-only audio that is routed to the right channel. Line input 1 is connected to an audio source associated with a sports-event "spotter" position. This source is routed to the headphone output's right channel. The input trim pot associated with line input 1 can now serve a critical role—adjusting the relative level of the "spotter" audio as compared to the level of intercom pin 3. The trim pot allows the desired "mix" to be created, providing the user with an effective cue signal.

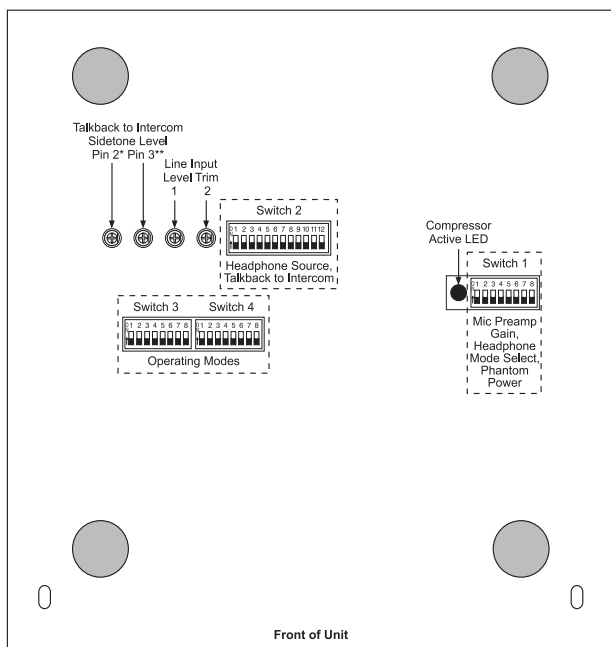

Figure 23. Bottom view showing line input and talkback-to-intercom sidetone trim pots

Intercom Interface Sidetone Adjustment

Associated with the talkback-to-intercom functions are sidetone trim potentiometers that are used to adjust the talkback levels that are returned by way of the intercom line cue audio source circuitry. These two trim pots are part of the analog hybrid circuit that separates (nulls) talkback audio from receive (listen) audio. If audio from either or both of the intercom channels is to be used as a headphone source, and talkback to these intercom channels has been configured, the sidetone trim pots may need to be adjusted.

One trim pot is associated with the sidetone level for each channel of the intercom interface. Both are accessible on the bottom of the Model 233's enclosure, adjacent to the trim pots associated with the line-level inputs. Adjusting them is very simple, requiring only a pair of ears and a screwdriver.

With the Model 233 configured as previously described, activate one of the talkback-to-intercom functions. Audio from the connected microphone may be heard in the configured headphone output channel(s). Adjust the trim pot associated with the active intercom channel so that the desired sidetone level, relative to the intercom receive level, is achieved. The adjustment range is approximately 18 dB, with the sidetone level increasing as the trim pot is rotated in its clockwise direction. Now change to the other intercom channel and adjust its sidetone trim pot as desired.

Using the Model 233's sidetone function, talkback audio will be routed to the headphone outputs by means of active

circuitry. If this is enabled be certain to place the two intercom sidetone trim pots to their fully counterclockwise positions. This will minimize the increase in sidetone level that will occur when both the main sidetone and the sidetone associated with talkback-to-intercom functions are active.

Technical Notes

Grounding and Shielding

As previously discussed in this user guide, the pin 1 connections on the 3-pin male XLR-type connectors associated with the main and line-level talkback outputs are "floating," i.e., not connected to anything within the Model 233's enclosure. Some audio experts might take offense to this, grousing that this should have been left to the user or installer to be connected or disconnected as desired. However repeated field testing found that floating pin 1 on these outputs was the key to maintaining quiet audio. From Fenway Park, to the Orange Bowl, and then northwest to Husker Stadium, lifting pin 1 always did the trick.

A simple solution is available if an application does require that a ground be available on the main and line-level talkback outputs' interconnecting cables. All Model 233 XLR-type connectors have a ground connection that is made to the interfacing connector's metal "shell." And most XLR-type connectors have a pin or connection point available to access its metal shell. By connecting the cable shield to the mating connector's shell terminal, the common connection typically found on audio interconnections is created.

Intercom Channel Crosstalk

By the very nature of its design, a 2-channel party-line intercom circuit is prone to exhibit crosstalk. This occurs because the audio paths are unbalanced (“single-ended”) and are typically transported on a single shielded twisted-pair audio cable. The primary causes of the crosstalk are the common signal return wire and the capacitance between the wires in the cable pair. The greater the capacitance, due to cable type and length, the more crosstalk there will be. It’s not surprising to find in sports broadcasting venues that audio from one channel can be heard “bleeding” into the other channel. Does this generally create a problem? No. But it can be a bit unnerving.

There are several ways of reducing intercom channel crosstalk. Probably the easiest way is to use cable pairs that are not twisted. Twisted pairs are great for differential (balanced) signals, but not so great for unbalanced transmission. This is generally because the more twists in a pair the greater the effective cable capacitance. In a stadium or arena setting, choosing standard “telco” pairs may actually work better than “high-performance” audio or data cable!

Another option is to use two cable pairs for each intercom circuit. If the pairs are not shielded the wiring is simple. Common would be connected to one side of each pair, and then signal from each channel would connect to the other side of the pairs. If the pairs also contain shields the wiring could be done somewhat differently. One option is to connect common to both cable shields, intercom channel 1 (DC with audio) to one full pair, and intercom channel 2 to the second full pair. A

better option might be to have common connect to both shields and one side of the pair that serves channel 2.

Intercom Audio Levels

The Model 233 was designed to function well with intercom lines associated with standard broadcast and production “party-line” intercom systems. These systems provide DC power and one or two channels of audio over standard 3-conductor cables that terminate with 3-pin XLR-type connectors. Establishing the correct “listen” and “talk” levels was critical in achieving good audio performance. In North America the two most common intercom systems are those from RTS and Clear-Com. From tests performed in Studio Technologies’ lab, the nominal RTS TW-series audio level is approximately -10 dBu. The dynamic range control provided by belt-packs such as the BP325 was very good, limiting the maximum level to at most 10 dB above the nominal. The nominal audio level associated with a Clear-Com system was harder to characterize. It appeared to be a few dB less than -10 dBu, but the dynamic range was much larger. Level peaks of 10 to 20 dB over nominal were easy to produce.

This objective data led to the following Model 233 design decisions: When audio from intercom channels 1 and 2 was used as headphone cue sources level sensitivity selection switches or trim pots were not required. The level range available on the Model 233’s front-panel controls proved to be sufficient for the user to be able to establish the desired listening level.

When talkback audio was routed to the intercom channels a single audio level proved to work well with both RTS and

Clear-Com systems. This was mainly possible due to the excellent dynamic-range-control provided by the compressor circuit. Its threshold (2 dB above Model 233 internal nominal level) and compression ratio (5:1) resulted in excellent talkback-to-intercom audio. So in the end, no level or compatibility switches of any kind were required to achieve the desired “listen” and “talk” performance.

The above paragraphs may elicit howls of protests from a host of engineers and intercom system experts. But for years we've heard differing reports as to the actual nominal audio levels for RTS and Clear-Com systems. The “in-the-know cats” agreed that RTS TW intercom (and IFB) was -10 dBu, a value that we confirmed in our tests. But the nominal level for Clear-Com was variously reported as -20 , -15 , -12 , -10 , and “you know, the Clear-Com level!” It's most likely that early Clear-Com systems did use a nominal level of approximately -20 dB. But after making controlled tests, the contemporary Clear-Com equipment seemed to be much closer to -10 dBu. And with the limited dynamic-range control that we experienced, the actual level during operation may vary widely. That's why intercom interface sensitivity or compatibility switches, or rotary controls were not included in the Model 233. But just in case a change is ever required intercom-interface gain levels are set using several $\frac{1}{4}$ -watt 1%-tolerance resistors. If necessary, these can be changed by a qualified technician.

In conclusion, the engineers at Studio Technologies are always open to learning more. Additional information from the field concerning such topics as intercom system levels, impedance matching, and DC power sourcing would be welcomed. Stopping

by our offices for an in-person chat would be also great. Bringing along a bit of road “swag” would be appreciated. Just park the production trailers in the alley behind our warehouse—plenty of power is available!

Connecting an IFB Circuit

A broadcast-standard “wet” (DC with audio) IFB circuit can be directly connected to the Model 233's intercom input. Originated by sources such as the RTS 4000-series IFB system or IFB interface devices from Studio Technologies, the connected IFB circuit can provide two channels of cue audio as well as DC power to operate the Model 233. No Model 233 talkback audio can be effectively sent to the IFB circuit due to its one-way nature. It's a low-source-impedance/high-input-impedance circuit arrangement.

The power supplied by an IFB circuit, normally in the range of 28 to 32 volts DC, is usually sufficient to operate the Model 233's circuitry. The acceptable input range is 24 to 32 volts, with a required current of 125 milliamperes. Note that the specified input voltage is given when measured directly at the Model 233's IFB input connector, not at the source of the IFB circuit.

In North American field and in-studio broadcast applications it is common to find RTS 4000-series IFB equipment being used to provide the IFB circuits. The Model 233 can be directly connected to, and function correctly with, one of these circuits. For reliable operation, especially when using lengthy cable runs, it's strongly recommended that no other device be connected to a 4000-series IFB circuit that is specified for connection to a Model 233. This requirement is due to the current-limited DC source that is supplied by the 4010 IFB Controller.

Phantom Power

The Model 233 provides a 48 volt nominal source of phantom power to support condenser-type microphones. It's designed to meet the P48 requirements as specified in the IEC 61938 standard. The circuitry is very simple: two 6.81 k ohm, 1%-tolerance resistors provide a path from a 48 volt DC source to pins 2 and 3 of the microphone input connector. The resistors and the power source work together to provide the required 48 ± 4 volts, up to a maximum current of 10 milliamperes.

Symptoms of Insufficient Power

A core part of the Model 233's internal circuitry is a switch-mode power supply that produces +48 volts, +12 volts, +5 volts, and -12 volts. This power supply circuit works very well as long as it is "fed" with sufficient input voltage and current. "Sufficient" is defined as a minimum of 24 volts on the intercom input and 20 volts on the external 24 volt DC input. The necessary current, 125 milliamperes for the intercom line and 90 milliamperes for the external source, must be supplied over their respective voltage ranges.

It's worth discussing what will happen if any of these power sources fall below their specified minimum. Typically, if the Model 233 is being powered by an external 24 volt nominal power source, normal operation will continue until the input falls to the 18-20 volt range. As the input voltage drops below this range the Model 233's internal power supply will have reduced stability, operating in this manner until its low-voltage shutdown circuit halts operation. Note that as the input voltage moves down from 24 volts the input current will rise proportionately to make up for the loss of power.

Using the intercom line to provide Model 233 power shouldn't prove to be a problem. Power supplies associated with broadcast and production intercom systems are designed to support multiple belt-pack and related devices. In the "big scheme of things," connecting a Model 233 shouldn't add a significant load.

LED Colors

As previously described, two LED indicators are associated with the main output and are located directly above the main output pushbutton switch. The red LED, located on the left, is lit whenever the main output is muted. The green LED, located on the right, is lit whenever the main output is active. The thought process behind the color choices was that red would relate to the main output being muted ("stop") while green would relate to the main output being active ("go"). It's possible that these color choices may not meet the needs of all users and applications. For example, it's reported that one European broadcaster typically uses these two colors in the opposite fashion. Their choice is to have the red LED lit whenever the main output is active, warning the talent that they are "on-air." The green LED is lit whenever the main output is muted, indicating to the talent that it's "safe" to say whatever they wish, about whomever they wish to say it about!

For consistency, the LED associated with each talkback button was selected to be green. They light whenever their associated talkback output is active. It's possible that some applications may benefit from revising these LED colors too. While red is certainly one possible choice, other colors are also a possibility including amber, orange, or blue—these days there are lots of choices available. The only limitation

is the amount of current available to light each LED. Using series resistors of no less than 560 ohms will ensure correct Model 233 operation.

A qualified technician can easily revise the LED colors to meet an application's exact needs. The process would begin by disassembling the Model 233's enclosure and detaching the pushbutton/LED printed circuit board assembly. The LEDs would then be unsoldered, removed, and reinstalled (or replaced) in the desired locations. To control the LED current and set the brightness, a resistor is electrically in series with each LED. An 820 ohm, ¼-watt resistor is associated with the red LED while a 560 ohm, ¼-watt resistor is associated with each green LED. These resistors would also have to be unsoldered, removed, and reinstalled. Then the unit would be reassembled and tested to confirm that the changes function as desired. For additional information about changing the LED colors, please contact Studio Technologies' technical support.

Travel Case

For portable applications it may be desirable to store and transport each Model 233 in a protective case. After much travel with prototype announcer console units, Studio Technologies personnel learned to appreciate the Pelican Model 1450 case. Purchased with the foam interior option, it does an excellent job of holding one Model 233, its associated 24 volt DC power supply, and documentation. Some applications may benefit from selecting a larger case that would also hold a related headset, cables, etc. A larger case could also be selected that would hold multiple Model 233 units. Pelican sells their products through a dealer network, many of which can be located via a web search.

Additional Connectors

Three spare connector locations are provided on the Model 233's back panel. From the factory they contain blank plates that can be readily removed and replaced with a variety of XLR-type connectors. These spare connector locations are specifically included so that a Model 233 can be customized to meet the many specific needs that arise in broadcast and related audio applications. Expected uses for these locations include adding a 6- or 7-pin XLR-type connector to allow direct connection of a broadcast headset. Other uses include creating "loop through" or "mult" functions for the line-level talkback output or intercom interface connections.

The spare connector locations are compatible with the Neutrik DL-series of connectors. For flexibility, versions are available that provide from three to seven contacts. For example, a compatible 3-pin female connector would be Neutrik part number NC3FD-L-1. To support headsets the NC6FDS-L-1 is often used. This is a 6-pin female connector with the unique Switchcraft 6-pin arrangement. The hardware that secures the blank plates to the Model 233's back panel is also intended to secure the replacement connectors.

If connectors are added to the Model 233's spare connector locations adding labels to those connectors can be helpful. For a great look it is recommended that Brother® P-Touch ¼-inch (6 mm) labels be created. Tape material that prints white text on a black background works out well for the Model 233. The Brother label cassette number TX-3151, white on black, is appropriate for use with many of their printers.

In addition to the spare connector locations on the back panel, provision has been made to allow easy interconnection with the Model 233's printed-circuit-board-mounted input and output connectors. This was accomplished by including numerous 3-position male "header" connectors on the Model 233's circuit board. These headers, on 0.1-inch centers, are wired in parallel with the Model 233's connectors. This "no solder" solution makes customizing a Model 233 a simple process. The headers, located on the Model 233's printed circuit board, are Molex® part number 22-23-2031. They mate with Molex housing number 22-01-3037. To make the interconnection, separate crimp terminals are attached to loose wires and then "snapped" into the housing. Molex part number 08-50-0114 specifies crimp terminals that are appropriate for wires of 22 to 30 gauge. These parts are available worldwide from sources such as Digi-Key, website www.digikey.com.

To make the process of connecting to the Model 233's headers a simple task an interface cable kit, part number 31087, is available from Studio Technologies. Each kit includes five cable assemblies and a length of heat-shrinkable tubing. Each cable assembly consists of a mating connector with three color-coded wires attached. These wires, nominally 12 inches in length, allow convenient soldering to a connector slated to be installed in a spare location on the Model 233's back panel. For reference, the wire color for pin 1 is gray, pin 2 is yellow, and pin 3 is blue.

The heat-shrinkable tubing is provided so that the connector solder cups can be insulated from each other. It will also provide some strain relief to the solder joints.

Be certain to slip the desired length of tubing over the wire prior to soldering a connection! (If this writer had a dollar for every time he forgot to put tubing on a wire (or slip on a connector shell) before making a solder connection...)

The Model 233's enclosure must be disassembled prior to installing connectors in the spare locations. Four hex-head machine screws, two on the bottom front of the enclosure and two on the back panel, must be removed. A 5/64-inch hex driver is required. The cover can then be carefully separated from the chassis, remaining attached by means of a flexible cable assembly. This "flex-cable" assembly links the main printed circuit board assembly with the board assembly that contains the pushbuttons and LED indicators. Ensure that the flex cable is not damaged while the Model 233 is being customized. For easier access, the push-button/LED board assembly can also be easily removed.

The 3-position headers on the Model 233's main circuit board assembly are located close to their related input or output connectors. The following list provides the printed circuit board reference numbers and associated functions.

P4: External 24 volt DC input, pin 1 common, pin 2 +24 volts, pin 3 not used. Back-panel 2.1 x 5.5 mm jack has +24 volts on center pin. Header P13 is used by the back-panel 24 Vdc jack assembly and is electrically in parallel with P4.

P5: Headphone output, pin 1 common, pin 2 tip (left), pin 3 ring (right).

P6: Microphone input, pin 1 common, pin 2 high, pin 3 low. Follows back-panel 3-pin female XLR pin assignment.

P7: Main output, pin 1 common, pin 2 high, pin 3 low. Careful! Back-panel 3-pin male XLR has pin 1 floating, pin 2 high, pin 3 low.

P8: Line-level talkback output 1, pin 1 common, pin 2 high, pin 3 low. Careful! Back-panel 3-pin male XLR has pin 1 floating, pin 2 high, pin 3 low.

P9: Line-level talkback output 2, pin 1 common, pin 2 high, pin 3 low. Careful! Back-panel 3-pin male XLR has pin 1 floating, pin 2 high, pin 3 low.

P10: Line input 1, pin 1 common, pin 2 high, pin 3 low.

P11: Line input 2, pin 1 common, pin 2 high, pin 3 low.

P12: Intercom interface, pin 1 common, pin 2 DC with channel 1 audio, pin 3 channel 2 audio. Follows back-panel 3-pin female XLR pin assignment.

P14: Pushbutton backlighting, pin 1 common, pin 2 button lamps, pin 3 current limited 24 volts from external 24 volt DC input.

P15: Auxiliary relay contact B, pin 1 normally closed, pin 2 common, pin 3 normally open.

P16: Auxiliary relay contact A, pin 1 normally closed, pin 2 common, pin 3 normally open.

P17: Internal power supply rails, pin 1 common, pin 2 +12 Vdc, pin 3 -12 Vdc.

P18: Remote talkback switch connections, pin 1 common, pin 2 talkback button 1, pin 3 talkback button 2.

P19: Remote main output/tally output connections, pin 1 common, pin 2 main output button, pin 3 tally output (+3.5 volt DC, 12 milliampere maximum).

Pushbutton Backlighting

For special applications, provision has been made to allow illumination (“backlighting”) of the three pushbutton switches. This may prove useful for applications where adequate room lighting is not available. It can also serve in custom Model 233 configurations. Note that this is an advanced feature, intended only to be implemented by a qualified technician.

From the outset several limitations must be discussed. The first is that button backlighting is not intended to serve tally applications. (A common connection to power all three lamps is provided; independent access to the lamp connections on each button is not provided.) It is strictly intended to provide a moderate amount of illumination to the button’s lens and associated labeling. The second restriction is that power for the backlighting function cannot be provided by an intercom line—it was felt that there may not be enough current available from this source to power both the Model 233 and light the lamps. However, power from the external 24 volt DC source can be used. This requires that this power source be connected whenever backlighting is desired.

From the factory, lamps (“bulbs”) are not installed in the pushbutton housings. They are pluggable T-1 bi-pin type and are simple to install. The mating socket is accessed by removing the button’s lens caps, graphic label, and back frosted lens. Compatible incandescent lamps with a nominal rating of 18 volts, 28 mA are available from Studio Technologies (part number 12030). Bulbs with other nominal voltages should also be available from electronics parts vendors. While compatible LED-based lamps are probably also available, incandescent lamps, when

powered below their rated current and voltage, can provide extremely long and reliable operation.

A 3-position header connector, labeled P14, is located on the Model 233's main printed circuit board. It provides access to, and a means to power, the three lamps. Pin 1 of the header is connected to the common point of the Model 233's circuitry, which is also connected to one contact on all the lamps. Pin 2 of the header is connected to the other contact on the lamps. Pin 3 is connected, by means of a current limiting resistor, to the external 24 volt DC source. If lamps were obtained from Studio Technologies then adding a "jumper" from pin 2 to pin 3 is all that is required to get things going. A standard 0.1-inch-center jumper, commonly used on electronic equipment, is all that is required. A 200 ohm, 2 watt resistor is electronically in series between the external 24 volt DC input and pin 3 of the header. When used with the lamps available from Studio Technologies, the resistor limits the lamp current to approximately 65 mA. This lights the lamps to a moderate intensity. If a different type of lamp is installed, its power source should be connected to pins 1 (common) and 2 (lamps) of the header.

Remote Control/Tally Connections

Provision has been made on the Model 233's printed circuit board assembly to allow external switches or contact closures to control the main output and talkback button functions. In addition, a DC "tally" output signal provides an indication of the status of the main output. Two 3-position headers provide access to the circuitry associated with these functions.

P18:

Pin 1 is connected to the common point of the Model 233's circuitry. Pin 2 is connected to the circuitry associated with the talkback 1 button. Pin 3 is connected to the circuitry associated with the talkback 2 button.

P19:

Pin 1 is connected to the common point of the Model 233's circuitry. Pin 2 is connected to the circuitry associated with the main output pushbutton. Pin 3 is connected to circuitry associated with the tally output.

The remote switch input circuits are "active low," with a 10 k ohm resistor connected to +5 volts acting as a pull up. A combination of resistors and capacitors provide ESD protection. The tally output is nominally 3.5 volts DC and is current limited to 12 milliamperes. This output can directly drive LED indicators. Using a series resistor in the range of 150 to 330 ohms is recommended. This will limit the current while still providing adequate LED light output.

Compressor Circuit

In this section some general information about the Model 233's compressor circuit will be provided. As previously discussed, the output of the microphone preamplifier circuit is connected to a studio-quality compressor circuit. The output of the compressor is used by the talkback functions and, if configured, the main output. (In most cases the main output will utilize the signal coming directly out of the microphone preamplifier.) The gain element in the compressor circuit is a laser-trimmed voltage-controlled-amplifier integrated circuit. It provides accurate, low-noise, low-distortion performance. The threshold of the compressor circuit is 2 dB above

the Model 233's nominal internal operating level of -2 dBu. A 5:1 compression ratio is implemented and, like the threshold level, is not field adjustable. The threshold and ratio settings were selected so that excellent talkback audio would be provided. By controlling the dynamic range, intelligibility can be improved and overloading of connected devices can be avoided. An LED indicator lights whenever the compressor's threshold has been reached and the circuit is actively controlling the dynamic range. This LED is provided as an aid when setting the gain of the microphone preamplifier.

Auxiliary Relay

The Model 233 provides an auxiliary relay for use in specialized applications. Some "head scratching" or "brainstorming" should lead to a number of interesting ways to take advantage of this unique resource. To implement any auxiliary relay application does require the services of a qualified technician. This is because the Model 233's enclosure must be disassembled and the desired wiring scheme implemented. The relay operates under software control, following the configuration selected using two of the DIP-type switches. Four operating modes are available: relay disabled, relay follows main output status, relay follows talkback 1 status, and relay follows talkback 2 status. These choices were previously discussed in this user guide and should be reviewed.

The relay provides two "form-C" contacts, each consisting of a common, normally open (not shorted), and normally closed (shorted) connection. Obviously the two form-C contacts change state in unison; two independent relay functions are not provided. These relay contacts are accessible on the Model 233's main printed

circuit board assembly by way of two 3-position header connectors labeled P15 and P16. The contacts are titled A and B, but there is no significance between the two. With both headers pin 1 is normally closed, pin 2 is common, and pin 3 is normally open. For additional details on connecting to the 3-position headers please refer to the Additional Connectors section in the Technical Notes area of this user guide.

Specifications

General Audio:

Frequency Response: 20 Hz-20 kHz, ± 0.1 dB, mic in/main out

Distortion (THD+N): 0.008%, measured at 1 kHz, mic in/main out

S/N Ratio: 80 dB, referenced to -46 dBu mic in/ -2 dBu main out

Connectors:

Mic In, Line In 1 & 2, Intercom Interface: 3-pin female XLR-type

Main Out, Talkback Out 1 & 2: 3-pin male XLR-type

Headphone Out: $\frac{1}{4}$ -inch 3-conductor phone jack

24 Vdc Power In: 2.1 x 5.5 mm coaxial power jack with locking bushing, compatible with Switchcraft S760K plug

Spare Connector Locations: 3

Allows up to three Neutrik NC*D-L-1 connectors to be installed (*=3F, 3M, 5F, 5M, 6F, 6FS, etc.)

Microphone Input/Preamplifier:

Type: electronically balanced

Input Impedance: 2 k ohms

Gain Range: 20 to 60 dB, adjustable in 10 dB steps

Compatibility: dynamic or phantom-powered mics

Phantom Power: 48 Vdc, nominal, meets IEC 61938

Compressor:

Threshold: 2 dB above nominal level

Attack/Release Time: 2 mSec/100 mSec

Slope: 5:1

Status LED: compressor active

Line Inputs: 2

Type: balanced, transformer-coupled

Impedance: 10 k ohms

Nominal Level: -12 dBV to $+6$ dBu, adjustable

Intercom Interface:

Type: 2-channel, unbalanced (pin 1 common; pin 2 DC with channel 1 audio; pin 3 channel 2 audio)

Compatibility: single- and dual-channel intercom systems such as from RTS™ and Clear-Com®

Impedance: 10 k ohms

Nominal Receive Level: -10 dBu

Nominal Talkback Level: -10 dBu

Sidetone (Null): 0 to -18 dB, adjustable

Main Output:

Type: balanced, transformer-coupled

Nominal Level: -2 dBu

Maximum Level: $+20$ dBu into 2 k ohms

Impedance: 100 ohms

Line-Level Talkback Outputs: 2

Type: transformer-coupled with series capacitors and isolation resistors

Impedance: 600 ohms

Nominal Level: $+4$ dBu

Maximum Level: $+11$ dBu (compressor restricts maximum)

Headphone Output: 1, stereo

Compatibility: intended for connection to mono or stereo headphones or headsets with nominal impedance of 100 ohms or greater

Type: voltage driver

Maximum Output Voltage: 8 Vpp, 150 ohm load

Auxiliary Relay:

Function: software configurable

Contacts: 2, form C (Common, Normally Closed, Normally Open)

Rating: 1 A, 30 W (resistive)

Access: requires user-implemented connector scheme

Tally Output: 3.5 Vdc, 12 mA maximum, nominal

Power Sources:

Intercom Interface: 24-32 Vdc, 125 mA

External: 24 Vdc, 90 mA @ 24 Vdc; acceptable range 20-30 Vdc. Units shipped to North America and Japan include a 120 V input/24 Vdc output power supply. Units shipped to all other locations include a universal input/24 Vdc output power supply.

Dimensions (Overall):

8.1 inches wide (20.6 cm)

3.3 inches high (8.4 cm)

8.5 inches deep (22.4 cm)

Weight: 4.5 pounds (2.1 kg)

Specifications and information contained in this User Guide subject to change without notice.

Appendix A

A label is attached to the security plate on the bottom of the unit. It provides a summary of the configurable parameters and related information. The actual label size 4.80 inches by 5.90 inches.

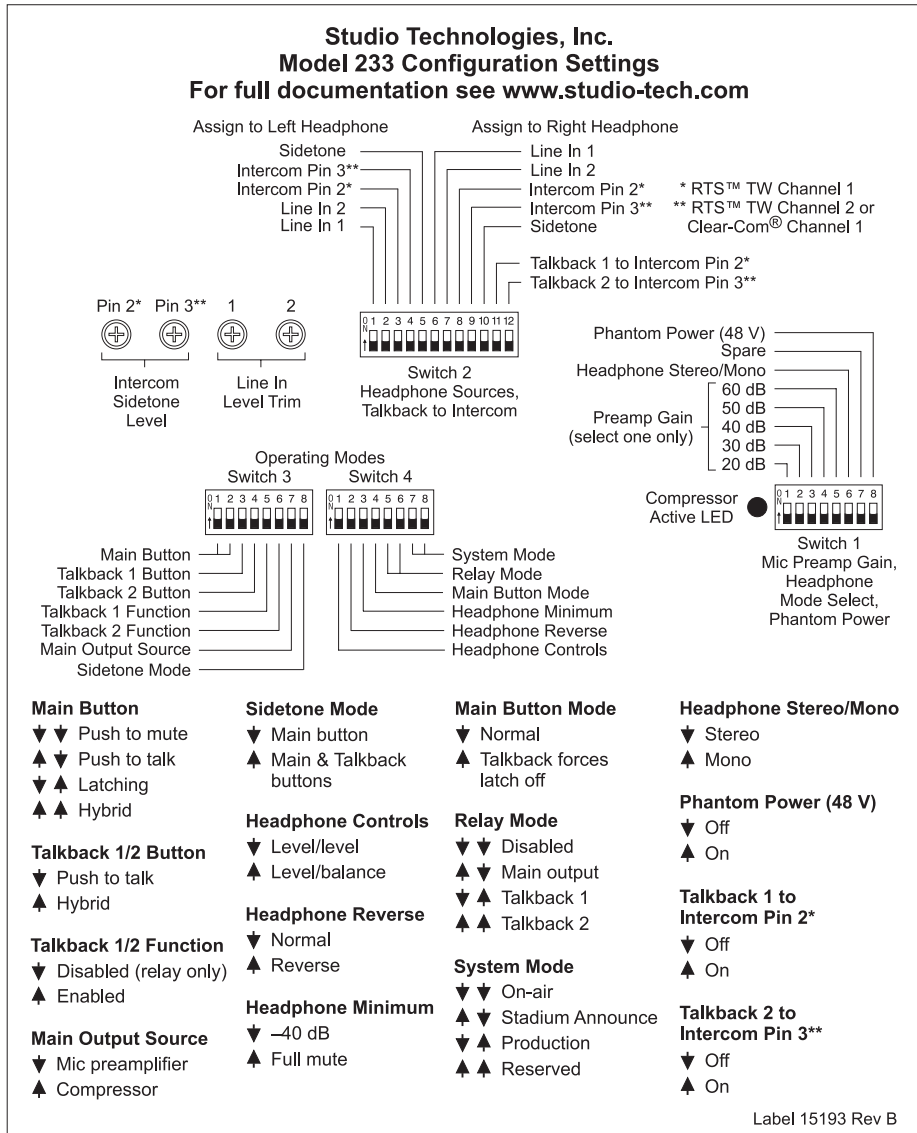

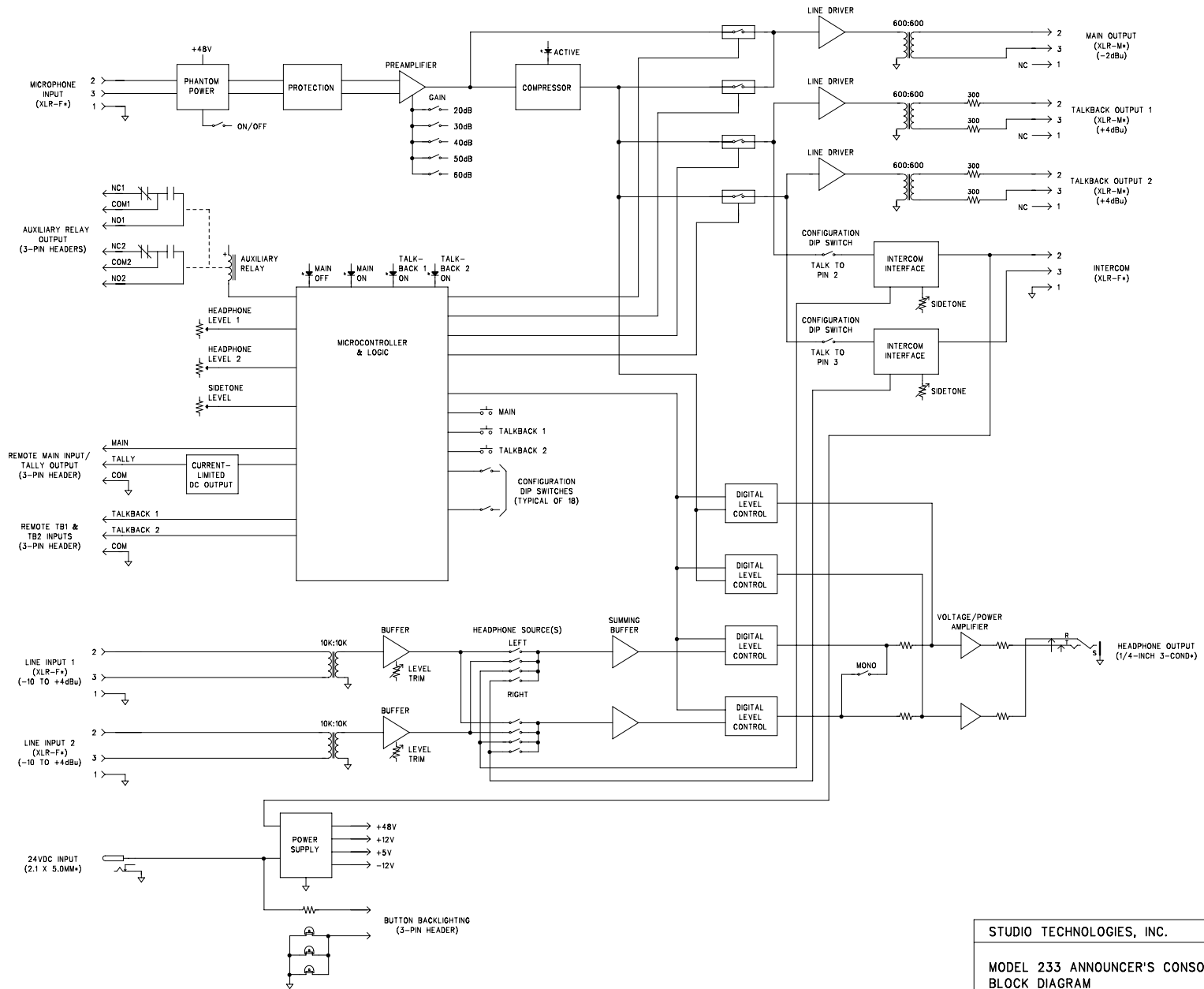

M2338D_A

STUDIO TECHNOLOGIES, INC.		
MODEL 233 ANNOUNCER'S CONSOLE BLOCK DIAGRAM		
DRAWING NO.	DATE	PAGE
31272	06/25/07	01 OF 01

+ ALSO HAS 3-PIN HEADER IN PARALLEL ON PRINTED CIRCUIT BOARD

